



Thermal Solutions Design Guide



Thermal Solutions Design Guide

Build the perfect solution today

This Design Guide is meant to provide introductory considerations for selecting appropriate heater technologies, as well as an index of heaters available for immediate shipment for testing and evaluation purposes. It also highlights design, integration, and assembly capabilities that enable Minco to work with you to develop comprehensive thermal solutions.

Getting Started

The Minco Difference 3

Selecting a Minco Heater..... 4

Heater Selection and Design

Thermofoil Solutions for Heating 6

Custom Design Options..... 7

Heater Insulations..... 10

Installing a Thermofoil Heater 11

Installation Method Comparison..... 12

Maximum Watt Density 13

Simulation Capabilities..... 15

Prototyping with Thermofoil Heaters 17

Heater Types

All-Polyimide (AP) Heaters 19

Mica Thermofoil Heaters 21

Polyimide Thermofoil Heaters 24

Silicone Rubber Thermofoil Heaters 27

Silicone Rubber Wire-Wound Heaters..... 29

SmartHeat Heaters..... 31

Thermal-Clear™ Transparent Heaters 34

Accessories

Thermostats 38

Pre-Cut Insulators..... 39

Sensors and Controllers

Temperature Sensors 41

Temperature Controllers 42

CT325 Miniature DC Temperature Controllers..... 43

CT425 Temperature Controllers 45

Reference

FAQ 48

Glossary 51

Industry Specifications for Heaters 54



Getting Started

The Minco Difference	3
Selecting a Minco Heater.....	4

The Minco Difference

Harness Minco's knowledge and diverse product lines to create the perfect solution

Custom and integrated components

Minco operates four different product lines, all coordinated in the same facility for faster, seamless integration that can boost your time-to-market. This makes us unique in our ability to customize and integrate components into turnkey assemblies and complete thermal, sensing and flex circuitry solutions. All of our components can be designed, manufactured, and integrated to perfectly fit your application while providing matched system accuracy.

Disciplined NPI Process

Minco has developed a disciplined approach for up-front engineering engagement. Our early involvement in your design cycle enables us to take steps to identify and reduce risk, minimize cost, and increase reliability.

- Minco's NPI approach reduces number of iterations
- Initial upfront design and manufacturability analysis performed at quote stage (DRC/DFM)
- Comprehensive, proactive design and process risk analysis to ensure robustness (DFMEA/PFMEA) and minimize delays

Custom solutions

Minco's customized products provide an affordable solution to meet your exact specifications. We work diligently to build our products with the greatest efficiency, quality, and accuracy to meet your critical standards and ensure ROI.

Minco can customize all of our products to perfectly fit your application.

Thermofoil Heaters

- Irregular shapes, size and holes for a precise fit
- Single or dual element for critical redundancy and rapid heat transfer
- Profiled and multi-zone heaters to put the heat exactly where you need it
- Leadwire, flex circuit or solder pad terminations for easy integration into your assembly

Sensors and instruments

- RTD and thermistor elements to match any TCR (temperature coefficient of resistance) curve
- A variety of materials and machining options available to provide critical thermal response in your application
- Leadwire and cable options to meet your application parameters
- Custom transmitters, controllers, and monitors for accurate sensing packages

E2E — Engineer to Engineer

Minco seeks to help our customers by connecting our engineers with theirs. We call this collaboration E2E.

Early engineering involvement:

Quality, robust designs are best achieved when the engineering collaboration begins early in the design cycle. Engineering consultation can be invaluable early in the design process. Minco wants to make your access to engineering tools and expertise as convenient as possible.

Minco engineer review: Our engineers will review your quote or order documentation and data to determine if changes are needed for manufacturability. If needed, we will discuss these issues with you to our mutual agreement before construction begins.

Design services: Concept to finish or problem specific, design engineers are available to assist our customers. Contact Minco to begin working with the design engineer most able to help you with your specific design needs.

Contact Minco today to learn how our engineers can help with your next project.



Flex Circuits

- Single-layer, double-layer, multilayer and rigid-flex circuits with high layer counts to meet your interconnection needs
- Fine lines, circuit forming and selective bonding add to space and weight savings
- Stiffeners, pins, connectors and full turnkey electronics packaging for efficient integration into your application
- Inductive communication coils can be integrated with flex circuits to provide critical communication assemblies

Integrated solutions

All of Minco's products – Thermofoil Heaters, Flex Circuits, Sensors, Instruments – can be integrated into a single component for greater efficiency. Whether it is a complete thermal optimization system or interconnection application, Minco's design engineers will partner with you to ensure success.

With integrated solutions there is less work on your end, and less that can go wrong. Our integrated assemblies truly lower your total cost of assembly because of less front end assembly, easy installation, and unparalleled quality and reliability.



Selecting a Minco Heater

Follow these steps to select your heater

1. Choose insulation type

Pick from the available insulation types. When selecting insulation consider temperature range, maximum resistance density and maximum heater size. Insulation options are available on page 7.

2. Choose installation option

Proper installation is crucial for optimal heater performance. Determine the best method to install flexible heaters in your application so you can achieve desired results in your thermal system. Minco installation options are available on page 8.

3. Calculate required wattage

The heater you select must produce enough power to (1) warm the heated object to control temperature in the desired time and (2) maintain that temperature. The specific heat formula on page 15 gives an estimate for warm-up, assuming all heat enters the object and none is lost. Add at least 20% to account for unknown losses.

Heat loss factors include conduction, convection, and radiation. A more accurate wattage estimate will take these into account. For a general discussion of heat

loss, download Minco White Paper “Estimating Power Requirements for Etched-Foil Heaters.” Also helpful is Thermal Calc, an online tool to assist with calculations. Both are available at www.minco.com.

4. Select a Minco stock or standard heater

Select from the hundreds of available heater sizes in this guide that will best fit your application. Multiple resistance options will allow you to carefully manage your heat output.

5. Test and prototype

The best way to make a final determination of heat requirements is by experimentation. See page 18 for tips, or download Minco’s white paper entitled “Prototyping Techniques for Etched-Foil Heaters,” available at www.minco.com.

Ohm’s Law

R Ohms (W)		P Watts (W)		I Amps (A)		E Volts (V)	
$\frac{E}{I}$	$\frac{E^2}{P}$	$\frac{P}{I^2}$	EI	I^2R	$\frac{E^2}{R}$	$\sqrt{\frac{P}{R}}$	$\frac{P}{E}$
$\frac{E}{I}$	$\frac{E^2}{P}$	$\frac{P}{I^2}$	EI	I^2R	$\frac{E^2}{R}$	$\sqrt{\frac{P}{R}}$	$\frac{P}{E}$
$\frac{E}{I}$	$\frac{E^2}{P}$	$\frac{P}{I^2}$	EI	I^2R	$\frac{E^2}{R}$	$\sqrt{\frac{P}{R}}$	$\frac{P}{E}$

A Thermofoil heater has a specific resistance. Its power output, in watts, depends on supply voltage ($P=E^2/R$).

Heater selection examples

Desired temperature	60°C	100°C		150°C
Power required	300 W at 115 V	500 W at 240 V		2500 W at 480 V
Heater size	3" x 6" (76.2 x 152.4 mm)	2" x 10" (50.8 x 254 mm)		9" (228.6 mm) diameter
Ideal resistance	$115^2/300 = 44.1$ W	$240^2/500 = 115$ W		$480^2/2500 = 92.2$ W
Mounting method	BM3 shrink band	#6 RTV cement	Factory vulcanized	Clamped
Insulation	Polyimide	Silicone Rubber		Mica
Model chosen	HK5468 R46.1 L12 A	HR5430 R96.8 L12 A		HM6810 R83.4 L12 T2
Effective area	15.74 in ² (101.5 cm ²)	18.20 in ² (117.4 cm ²)		58.5 in ² (377.4 cm ²)
Actual power	$115^2/46.1 = 287$ W	$240^2/96.8 = 595$ W		$480^2/83.4 = 2762$ W
Watt density	$287/15.74 = 18$ W/in ² (2.79 W/cm ²)	$595/18.20 = 33$ W/in ² (5.12 W/cm ²)		$2762/58.5 = 47$ W/in ² (7.29 W/cm ²)
Max. watt density	36 W/in ² (5.58 W/cm ²) at 60°C	19 W/in ² (2.95 W/cm ²) at 100°C	36 W/in ² (5.58 W/cm ²) at 100°C	54 W/in ² (8.37 W/cm ²) at 150°C
Wattage density OK?	Yes (18 < 36)	No! (33 > 19)	Yes (33 < 36)	Yes (47 < 54)

Selection and Design

Thermofoil Solutions for Heating	6
Custom Design Options	7
Heater Insulations	10
Installing a Thermofoil Heater	11
Installation Method Comparison	12
Maximum Watt Density	13
Simulation Capability	15
Prototyping with Thermofoil Heaters	17

Thermofoil™ Solutions for Heating

Industry-leading heater technology

Flexible Thermofoil™ Heaters

Thermofoil™ heaters are thin, flexible components consisting of an etched-foil resistive heating element laminated between layers of flexible insulation. Since their introduction by Minco over 55 years ago, Thermofoil heaters have demonstrated significant advantages over conventional electric heaters.

Precise heating

Thermofoil heaters put heat where you need it. You simply apply them to the surface of the part to be heated. The thin construction provides close thermal coupling between the heater element and heat sink. You can even specify profiled heat patterns with higher watt densities in areas where heat loss is greater.

Faster warmup and longer life

The flat foil element of Thermofoil heaters transfers heat more efficiently, over a larger surface area, than round wire. Thermofoil heaters, therefore, develop less thermal gradient between the resistive element and heat sink. Heaters stay cooler. The result is higher allowable watt densities, faster warmup, and prolonged heater life. Thermofoil heaters can safely run at wattages twice those of their wire-wound equivalents. Insulation life may be ten times greater. For high levels of reliable heat, the obvious choice is Thermofoil.

Space and weight savings

A polyimide (e.g. Kapton™) heater typically weighs only 0.009 oz/in² (0.04 g/cm²) and measures just 0.010" (0.25 mm) thick over the element. For applications with limited space — defense electronics, aircraft, portable medical instruments, high density electronic devices — Thermofoil heaters deliver the heat you need.

Custom and integrated components

Minco's four different product lines, all coordinated in the same facility for faster, seamless integration that can improve your time-to-market. This makes us unique in our ability to customize and integrate components into turnkey assemblies and complete thermal, sensing and flex circuitry solutions. All of our components can be designed, manufactured, and integrated to perfectly fit your application while providing matched system accuracy.

We can furnish heaters with integral resistance temperature detectors (RTDs), thermocouples, thermistors, or thermostats. Minco controllers can monitor sensors and power heaters for



tight control and accuracy. And, with flex circuit capabilities and in-house pick-and-place equipment, control circuitry can be incorporated in the same assembly to save you assembly time and cost.

Custom tailored for better fit

Size and shape possibilities are limitless. Minco can manufacture heaters as large as 8 feet (2.4 m) long, and smaller than 0.25" x 0.25" (6.4 mm x 6.4 mm). You can specify intricate geometries to follow the bumps and curves of your hardware at the same time designing the heater for best accuracy and reliability.

Value-added assembly

As an added service, Minco can laminate, vulcanize, or clamp heaters to mating heat sinks. Our specialized equipment guarantees tight bonds, high reliability, and superior performance. We can mount the heater to your furnished parts, or provide machined heat sinks to offer you a complete turnkey solution.

Best fit — best price

Minco's custom heaters are typically more cost effective than our standard models at OEM quantities (e.g. 500+ pieces). Start with our off-the-shelf solutions for experimentation and proof-of-concept testing. Then, we'll work with you to optimize a custom solution. Contact us early in the design process so our expert engineers can help you design the best and most efficient heating solution available.



Custom Design Options

Heater designs to perfectly fit your application

Minco's Unmatched Design Options

Thermofoil heaters give you design options that other heater types can't match. Minco's custom design options can be quantified into three sections.

Element design: Element patterns, outline shapes, heat profiles and terminations can be fine-tuned to create the exact thermal and physical component to fit your unique requirements. Get more information below.

Integrated components: Integrating temperature sensors directly into the Thermofoil heater improves your thermal control while at the same time simplifying the end-use assembly operation.

Value-added services: Complete thermal sub-assembly can provide a turnkey solution for your application. This could entail factory mounting of heaters to fabricated heat sinks, SMT control electronics to the Thermofoil heaters, incorporated rigid multi-layer flex circuits and connector termination.

Heater outline shapes

With a 3-dimensional approach the possibilities are endless. Select the proper Thermofoil heater insulation to meet your electrical and thermal performance requirements while at the same time satisfying your demanding packaging needs. Using selective adhesive backing configurations will also promote ease of installation of our heaters within smaller and smaller device spaces. Minco also has tooling and lasering capabilities which allows us to provide complex part outlines (holes, cut-outs, radii) with very tight dimensional tolerances.

Profiled heater conductor routing

A profiled element levels out temperature gradients by providing extra heat where losses occur, such as along edges or around mounting holes. In a typical case, profiling might reduce a $\pm 25^{\circ}\text{C}$ temperature variation across a surface to $\pm 5^{\circ}\text{C}$ or better. Once the best profile is determined for the application, Minco's photo-etching process ensures repeatability from heater to heater.

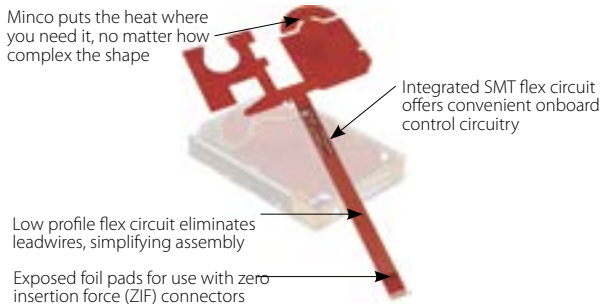





Methods to derive the profiling pattern include:

- **Experimentation:** Lay out a pattern with standard heaters and vary the power levels until temperature reaches the desired uniformity. Or, Minco can provide a custom heater with separately powered zones for prototyping. Minco will then reproduce the successful profile with a single element.
- **Finite Element Analysis (FEA):** Although more expensive, FEA modeling of thermal systems can reduce the number of trials required to design a profiled heater. It may help to map the temperature resulting from uniform heat input (using a standard heater), then work backward in FEA to derive the profiled pattern.

Other heater element options

- Dual element for redundancy and/or warm-up and maintenance heating schemes
- Non-magnetic alloys for inductance canceling
- Dual layer constructions in order to provide higher resistance (ohms) in small areas or for added inductance canceling in element patterns

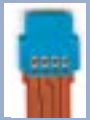
Electrical termination

Leadwires (standard) 	<ul style="list-style-type: none">• Welded leadwires make a strong, reliable connection. Options include different colors, sizes, and insulating materials.
Solder pads 	<ul style="list-style-type: none">• Lowest cost, but limits foil/resistance options.
Connectors 	<ul style="list-style-type: none">• Insulation displacement connectors crimped onto etched leads make an economical design. Other connector types are available such as pin headers, SMT and ZIF termination.
Flex circuits 	<ul style="list-style-type: none">• Minco can supply flex circuits integrally connected with heaters.

Custom Design Options

Value-added assemblies and complete thermal solutions.

Overview

For best heater performance and reduced installation costs, consider Minco's capabilities in mounting heaters to make complete thermal subassemblies. You can furnish the heat sinks or we can fabricate them to your specifications. Either way, you get a guaranteed bond, superior reliability, and the benefits of Minco's experience with advanced adhesives and lamination equipment. In many cases we can affix the heater to the mating part in the same step used to bond its layers together. That saves money over a two-step process.

Vulcanized silicone rubber assemblies

Minco's proprietary vulcanization process uses no adhesive to bond heaters to mating parts. Eliminating the adhesive facilitates heat transfer, resulting in higher allowable watt densities and longer life.



Laminated polyimide heaters

Polyimide (e.g. Kapton™) heaters can be mounted to flat or curved heat sinks using an acrylic adhesive and our specialized lamination equipment. The thin, uniform bond layer provides excellent heat transfer. Watt densities to 50 watts/in² (7.8 watts/cm²) are possible.



Clamped mica heaters

Mica heaters must be secured between rigid plates to prevent separation of layers. Minco can provide many styles of mica heater assemblies: bolted, riveted or welded, flat or curved.

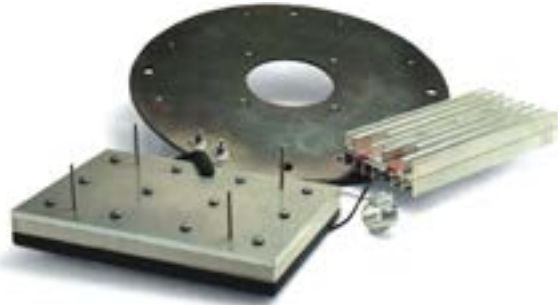

Factory mounted All-Polyimide (AP) heaters

Factory bonded AP heaters eliminate clamping and provide optimum heat transfer to the heat sink. The excellent chemical resistance and low outgassing of AP heaters, together with Minco's precise machining capabilities, are the perfect solution for chuck heaters in semiconductor processing equipment.

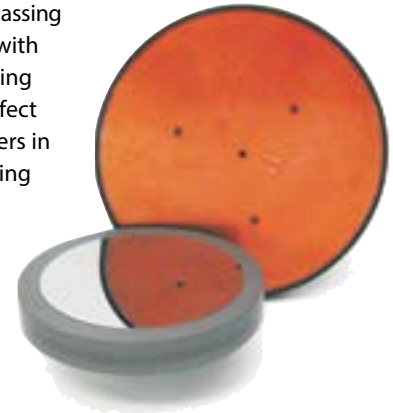

Assembly options

- Minco-supplied heat sinks: Machined, formed, and extruded parts from Minco's advanced machine shop or qualified vendors
- Coatings: PTFE coating, anodizing, or plating with nickel, copper, gold, or parylene.
- Temperature sensors: Accurate and reliable temperature measurement. See the "Sensors, Controllers & Accessories" section for more information
- Thermostats and thermal cutoffs for control or limit switching
- Wire harnesses, connectors, or flex circuitry
- Electronic components
- Thermal insulation

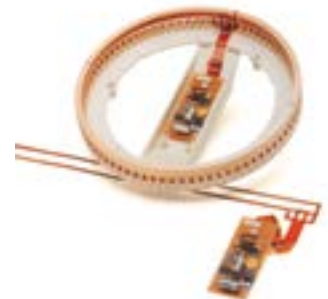

Custom Design Options







Integrating sensors and thermal cut-outs

Temperature sensors

Integrating sensors into heaters simplifies your assembly operations by providing a gradient-free system with excellent temperature control. The sensor sits in a window of the heating element. It reacts to temperature changes in the component

beneath the heater, yet remains close to the heating element itself. This tight coupling of heater, sensor, and heat sink can greatly improve heating control and accuracy. Sensors can be electrically connected via leadwires or flex circuitry.

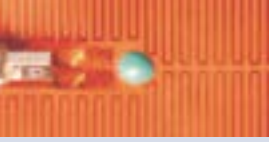
Types of sensors used in heater/sensors

	Description	Options	Features
	<p>Surface Mount RTDs and Thermistors</p> <p>Miniature sensors mounted via surface mount technology</p>	<ul style="list-style-type: none"> Low installed costs Geared for medium to high volumes Fast time response Stable and accurate 	<ul style="list-style-type: none"> Sizes: 0805, 0603, 0402 RTD: 100Ω and 1KΩ platinum; ±0.06% or ±0.12% at 0°C (DIN class A or B) Thermistor: 10KΩ and 50KΩ; ±1% at 25°C
	<p>Thin-film RTDs</p> <p>Small ceramic elements laminated inside the heater or located on top</p>	<ul style="list-style-type: none"> Highly stable and accurate Standardized output Low cost Tight resistance tolerance 	<ul style="list-style-type: none"> Platinum, 0.00385 TCR 100 to 10,000 Ω Wire leads or SMT 0.12% or 0.06% tolerance
	<p>Strip-wound RTD</p> <p>Sensing wire wound around a flexible insulating strip and encapsulated inside heater</p>	<ul style="list-style-type: none"> Can average temperatures along length of sensor. Any resistance possible 	<ul style="list-style-type: none"> Platinum, nickel, nickel-iron.
	<p>Flat-wound RTD</p> <p>Sensing wire laid in a predetermined pattern in a single plane</p>	<ul style="list-style-type: none"> Fast response (0.1 sec.) Can average temperatures along length of sensor. 	<ul style="list-style-type: none"> Platinum, nickel, nickel-iron Uniform or profiled
	<p>Etched RTD</p> <p>Heater and RTD etched from same temperature sensitive foil</p>	<ul style="list-style-type: none"> Lowest cost Fast response Can average temperatures along length of sensor. 	<ul style="list-style-type: none"> Nickel or nickel-iron
	<p>Thermistor</p> <p>Bare or coated bead embedded in heater or placed on top and covered in epoxy.</p>	<ul style="list-style-type: none"> High sensitivity Low to moderate cost 	<ul style="list-style-type: none"> NTC or TC Variety of resistances Bead or SMT
	<p>Thermocouple</p> <p>Junction of dissimilar metals laminated inside heater</p>	<ul style="list-style-type: none"> Minimal space required Rugged construction Wide temperature range 	<ul style="list-style-type: none"> Wire or foil E, J, K, or T standard
	<p>Thermostat</p> <p>Low cost basic heater control or thermal cutoff.</p>	<ul style="list-style-type: none"> No external controller Low system cost 	<ul style="list-style-type: none"> Snap action or creep action Specify setpoint Wired/mounted to heater

Heater Insulations

Compare the insulations Minco uses in its heaters



Material	Temperature range	Max. size	Max. resistance density*	Comments
Polyimide/FEP Polyimide film with teflon adhesive	-200 to 200°C -328 to 392°F	560 mm × 1065 mm 22" × 42"	70 Ω/cm ² 450 Ω/in ²	See technical specifications on pages 22-24.
Silicone rubber Rubber film with rubber adhesive	-45 to 235°C -49 to 455°F	560 mm × 2285 mm 22" × 90"	31 Ω/cm ² 200 Ω/in ²	See technical specifications on pages 25-26 (foil) and pages 27-28 (wire-wound)
Mica Mica insulation with temporary binder	-150 to 600°C -238 to 1112°F	560 mm × 1168 mm 22" × 46"	3.9 Ω/cm ² 25 Ω/in ²	See technical specifications on pages 19-22.
Optical grade polyester Polyester film with acrylic adhesive	-55 to 120°C -67 to 248°F	280 mm × 560 mm 11" × 22"	185 Ω/cm ² 1200 Ω/in ²	See technical specifications on pages 32-34.

*Resistance density varies with the size of the heater (higher density possible with smaller heaters).

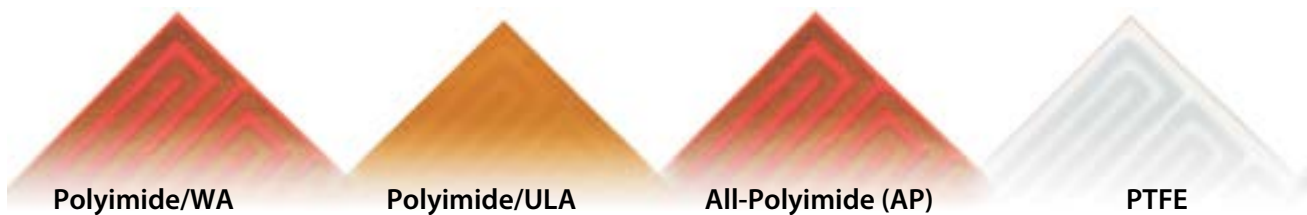

Material	Temperature range	Max. size	Max. resistance density*	Comments
Polyimide/WA Polyimide film with thermosetting acrylic adhesive (not UL recognized)	-200 to 150°C -328 to 302°F	560 mm × 1825 mm 22" × 72"	230 Ω/cm ² 1500 Ω/in ²	Similar to Polyimide/FEP except lower cost, higher resistance densities, and lower temperature range. WA is preferred over FEP for most custom designs under 150°C.
Polyimide/ULA Polyimide film with UL recognized thermosetting acrylic adhesive	-200 to 150°C -328 to 302°F	560 mm × 1825 mm 22" × 72"	230 Ω/cm ² 1500 Ω/in ²	Similar to Polyimide/WA except UL recognized (UL94V-0).
All-Polyimide (AP) Polyimide film with polyimide adhesive	-200 to 260°C -328 to 500°F	560 mm × 1145 mm 22" × 45"	230 Ω/cm ² 1500 Ω/in ²	Higher temperatures and watt densities than industry standard flexible Polyimide construction.
PTFE Teflon film with Teflon adhesive	-200 to 260°C -328 to 500°F	254 mm × 1016 mm 10" × 40"	70 Ω/cm ² 450 Ω/in ²	Fully sealed construction suitable for immersion in acids, bases, and other corrosive chemicals.

Installing a Thermofoil Heater

Choose the best method for your application

Versatile Thermofoil heaters allow a variety of mounting methods. Proper installation is crucial to heater performance. The heater must be in intimate contact with the surface beneath, as any gaps can block heat transfer and cause a hot spot resulting in premature heater failure.



Proper installation ensures good heat flow from the heater to the heat sink



Voids or bubbles beneath the heater cause localized hot spots which can result in premature heater failure

Pressure-sensitive adhesive (PSA)



With factory-applied PSA, you simply remove the backing paper and press the heater in place.

Description	Temperature rating	Comments	Installation Instruction*
Acrylic PSA 0.002" (0.05 mm) acrylic film	See heater ordering information	<ul style="list-style-type: none"> NASA approved for outgassing Flat surfaces only, unless aluminum backed 	SPI 00-0603
#12 PSA 0.002" (0.05 mm) silicone film		<ul style="list-style-type: none"> Flat or slightly curved surfaces 	SPI 00-0598

Epoxy and cement



Liquid adhesives require more care in application than PSA, but generally provide higher temperature/wattage performance.

Description	Temperature rating	Comments	Engineering Instruction*
#6 RTV Cement Room temperature vulcanizing silicone for rubber heaters	-45 to 235°C -49 to 455°F	<ul style="list-style-type: none"> Distance from center of heater to edge must be less than 5" (127 mm) 3 oz. (85 g) tube covers 800-1300 in² (5000-8000 cm²) 	EI 117
#15 Epoxy 2-part epoxy for Polyimide heaters	-70 to 115°C -94 to 239°F	<ul style="list-style-type: none"> NASA approved for outgassing Bi-pack covers 150-300 in² (900-1800 cm²) 	EI 507

Easy installation methods for cylindrical surfaces



Built-to-order shrink bands are pre-stretched strips of film with adhesive coated ends. Wrap around the heater and heat to shrink. Stretch tape installs quickly with no heat required.

Description	Temperature rating	Comments	Engineering Instruction*
BM3 Shrink Band Polyester strip	-73 to 149°C -100 to 300°F	<ul style="list-style-type: none"> To order, specify band width and cylinder diameter 	EI 103
BK4 Shrink Band Polyimide strip	-73 to 177°C -100 to 350°F		
#20 Stretch Tape Self-fusing silicone tape	-51 to 200°C -60 to 392°F	<ul style="list-style-type: none"> Comes in 6 or 36ft (1.8 to 11 meters) rolls, 1" (2.54 cm) wide. Figure 25% overlap when calculating length required. 	EI 124

Clamping

Mechanical clamping is required for mica heaters, optional for polyimide, but not recommended for rubber. Call Minco and ask for Minco Installation Instruction EI 347 or go to www.minco.com.



Installation Method Comparison

Minco offers numerous options for installation

Method	Description	Usage notes	Compatible Heater Technologies					
			Polyimide	All-Polyimide	Silicone Rubber Foil	Silicone Rubber Wire-wound	Mica	Thermal-Clear Transparent
Factory lamination	Factory mounting to flat or curved heat sinks using an acrylic adhesive and our specialized lamination equipment	<ul style="list-style-type: none"> Thin, uniform bond layer provides excellent heat transfer Enables watt densities up to 50 watts/in² (7.8 watts/cm²) 	X	X				
Factory vulcanization	Factory mounting using no adhesive to bond heaters to mating parts	<ul style="list-style-type: none"> Uncured silicone rubber layer heat and pressure bonded to the heat sink Excellent heat transfer enabling watt densities up to 60 watts/in² (9.3 W/cm²) Intimate bond of heater-to-heat sink providing long lasting and reliable heater solution 			X	X		
Pressure Sensitive Adhesive (PSA)	Acrylic PSA: 0.002" (0.05 mm) acrylic film, simply remove the backing paper and press the heater in place	<ul style="list-style-type: none"> NASA approved for outgassing Flat surfaces only Uniform thickness Easy to apply 	X					X
	Acrylic PSA with aluminum backing: 0.002" (0.05 mm) acrylic film with 0.003" aluminum backing	<ul style="list-style-type: none"> Flat or slightly curved surfaces Added advantage of heat spreading Uniform heat distribution 	X		X	X		
	#12 PSA: 0.002" (0.05 mm) silicone film, simply remove the backing paper and press the heater in place	<ul style="list-style-type: none"> Flat or slightly curved surfaces Uniform thickness Easy to apply 6 month expiration 	X	X	X	X		
Liquid Adhesives	#6 RTV cement: room temperature vulcanizing silicone	<ul style="list-style-type: none"> Distance from center of heater to edge must be less than 5" (127 mm) 3 oz. (85 g) tube covers 800-1300 in² (5000-8000 cm²) -45 to 235°C (-49 to 455°F) 			X	X		
	#15 epoxy: 2-part epoxy adhesive	<ul style="list-style-type: none"> NASA approved for outgassing Bi-pack covers 150-300 in² (900-1800 cm²) -70 to 115°C (-94 to 239°F) 	X					
Banding and tape	BM3 shrink band: built-to-order, pre-stretched polyester strip with adhesive coated ends	<ul style="list-style-type: none"> Wraps around the heater and heated to shrink Specify band width and cylinder diameter -73 to 149°C (-100 to 300°F) 	X		X	X		
	BK4 shrink band: built-to-order, pre-stretched polyimide strip with adhesive coated ends	<ul style="list-style-type: none"> Wraps around the heater and heated to shrink Specify band width and cylinder diameter -73 to 177°C (-100 to 350°F) 	X		X	X		
	#20 stretch tape: self-fusing silicone tape	<ul style="list-style-type: none"> Installs quickly with no heat required 6 or 36ft (1.8 to 11 meters) rolls, 1" (2.54 cm) wide Add 25% for overlap when calculating required length -51 to 200°C (-60 to 392°F) 	X		X	X		
Mechanical clamping	Heater secured between rigid plates to prevent separation of layers	<ul style="list-style-type: none"> Available styles include bolted, riveted or welded, for flat or curved surfaces 	X	X			X	X

Maximum Watt Density

Calculate maximum allowable power

Overview

The watt density tables on the following page show the maximum allowable power for each heater type, expressed in watts per square inch, or centimeter, of effective area. The rating depends upon the heater's insulation/internal adhesive, heat sink control temperature, and the mounting method.

If watt density exceeds the maximum rating, the heater is in danger of overheating and premature failure. To obtain more power:

- Select a larger size heater
- Consider other heater insulation materials, e.g. mica
- Change the mounting method
- Use proportional control to reduce power as the heat sink temperature rises
- Contact Minco for product and design assistance

In addition to wattage, you should calculate the current (I) through the heater leadwires to keep it within the maximum rating for the AWG wire size used.

Using watt density charts

1. Look up the effective area for the heater model in question. This is total heater area minus borders and lead attachment space (calculated by Minco).
2. Divide the power requirement in watts by this area to obtain watt density.
3. Draw a line from the heat sink temperature (at the bottom of the chart) to the line labeled with the mounting method and/or insulation you have chosen.
4. The maximum watt density is indicated by the value on the left or right axis that corresponds with that intersection.

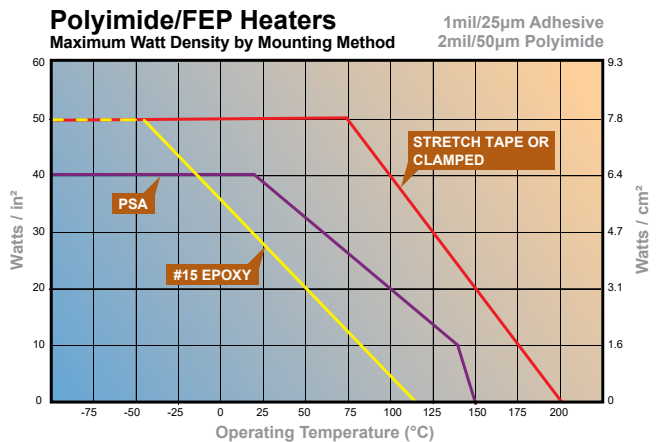
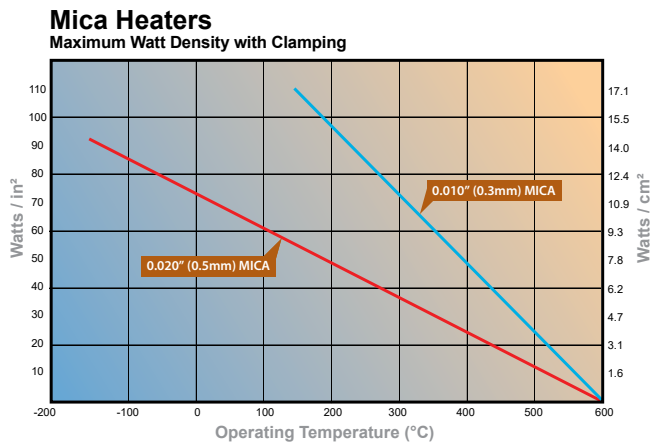
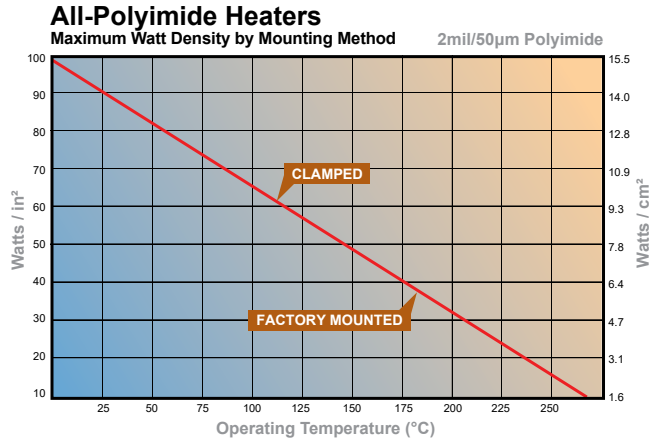

Maximum Watt Density

Refer to these parts when computing watt density

Silicone Rubber Thermofoil Heaters .008"/0.2mm Silicone Rubber
Maximum Watt Density by Mounting Method

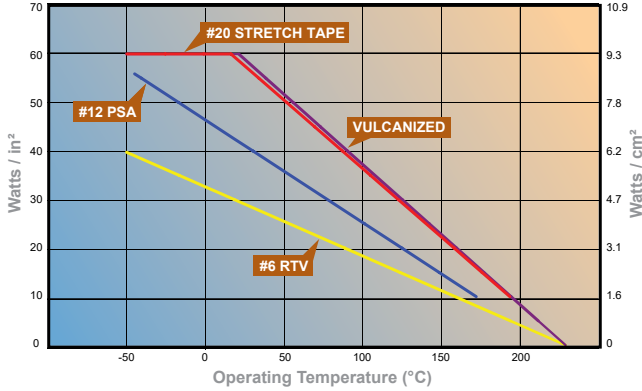

WA Heaters 1mil/25µm WA 2mil/50µm Polyimide
Maximum Watt Density by Mounting Method

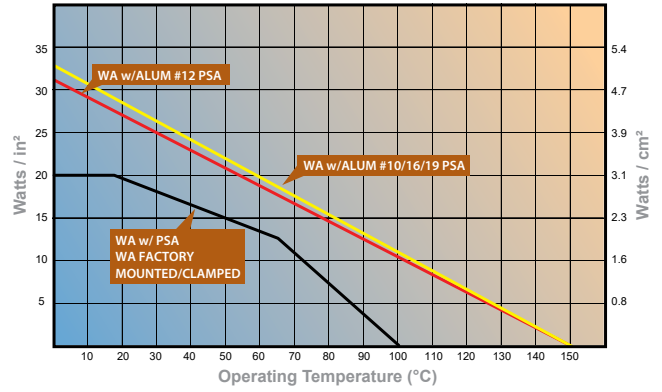

Thermal-Clear™ Heaters 2mil/50µm Polyester 2mil/50µm Adhesive
Maximum Watt Density with Acrylic PSA

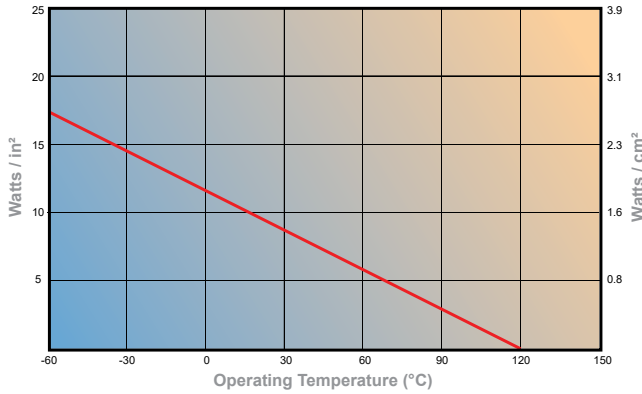

Wire-Wound Rubber Heaters 0.025"/.63mm Silicone Rubber
Maximum Watt Density by Mounting Method

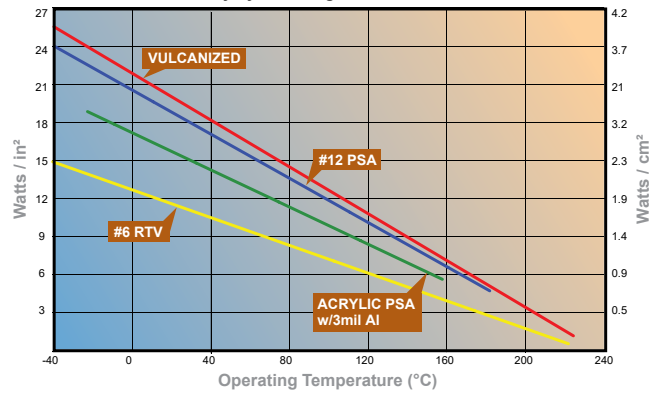

Simulation Capabilities

Minco offers thermal simulations to ensure proper heater design

Choosing Minco for Thermal Simulations

When you choose Minco to create a thermal simulation, you are partnering with expertise in providing complete integrated thermal solutions for the most critical applications—in markets where failure is not an option. Minco performs more than 500 thermal simulations in a year. Why trust your critical simulations to anyone with less expertise?

Minco will take you beyond the simulations with our well-equipped facilities for test and validation. Our thermal testing tools include: Labview for thermal data collection; Dedicated thermal test carts (SV, A/D, sensors, etc.); IR Cameras; Custom thin film sensor arrays; Vacuum chamber; CTH Chambers; HALT Chamber; Micro-section lab; analytical services; shock/vibration testing; digital X-ray and CT imaging; and thermal test chambers from -70°C to 170°C to simulate extreme environments.

Involve Minco early in the design

Our customers benefit the most when Minco is engaged in the early stages of design. They realize that the heater is not an isolated component but an integral part of a thermal system. Minco excels in delivering cost-effective, high performance systems, working as an extension of your engineering team. We ask you to provide your problems, not just your prints. Early involvement allows designing for improved manufacturability and lower cost.

Why Request a Thermal Simulation?

Traditional thermal design consisted of a design proposal, procurement of physical prototypes, performance testing and validation followed by pre-production and production. The steps through testing and validation were iterative. The more complex the design parameters were, the more iterations of prototype and test were required to achieve optimal performance. Traditional thermal design is an expensive proposition when you consider the cost of physical investments in testing and the lost time to market.

Simulation-based thermal design uses computer modeling to predict product performance and allows for design modifications within the model to optimize your thermal parameters before committing to physical prototypes. While there are up-front costs associated with simulation-based design, the savings over traditional iterative prototyping can be substantial. In most cases, a single iteration of physical prototype will meet the demands of the application.

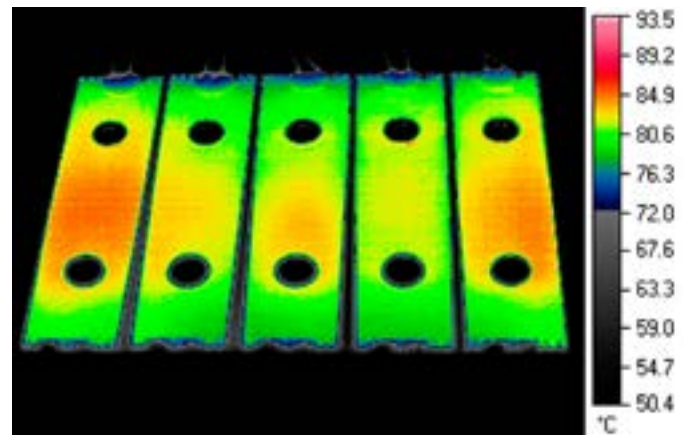

FEA/CFD Analysis

Minco works with modeling to simulate performance of your system under various conditions, create design alternatives for comparison and ultimately provide an optimal design solution.

We offer two different methods of analysis: Finite Element Analysis (FEA) and Computational Flow Dynamics (CFD). FEA only addresses environmental conditions brought about by conduction, such as the routine heating of the heat sink. CFD, by contrast, also addresses less predictable environmental conditions like air currents or the flow of ink.

Basic parameters we evaluate include:

- Thermal uniformity of the system when using a non-optimized uniform heat source
- Warm-up time given a maximum wattage
- Warm-up power requirements to achieve a time goal
- Steady-state power requirements to maintain a process (with more efficient use of power) and recommended safety margins based on material conditions.

Going beyond the basics, the models can be used to:

- Optimize thermal uniformity of the system by profiling the wattage distribution of the heat source.
- Model different temperature sensing locations to ensure optimal system responsiveness.
- Evaluate thermal uniformity at multiple control temperatures.
- Identify control loop problems.
- Evaluate heat sinks for deformation and expansion issues.
- Test modifications to heat sinks and other hardware in to optimize thermal performance.

See the next page for a list of requirements for either type of analysis.



List of Requirements for Analysis

Refer to the following list while preparing your project for thermal analysis. The more detail our engineers receive, the more accurate and useful the simulation will be.

1. Problem Statement

What “question(s)” need to be answered by this analysis?

- Generally the customer is interested in solving one or more of the Thermal Requirements from below.

2. Definition of the Environment

All of the drawings, files, and notes that would help our engineers accurately simulate the environment in which the heater will be operating. The CFD analysis takes into account much more environmental factors, and as such will require additional data over the FEA.

- **3D CAD files (preferable) or Drawings**
 - Heat Sink, hardware, enclosures, etc.
 - Parasolid, .STEP file, or .IGES file
 - 3D CAD for EVERYTHING around or near the part (CFD only)
 - 3D CAD for materials being processed (solids to be melted, for example)
- **Bill of Materials (BOM)**
 - Unique materials should be provided with material properties for the range of temperatures being calculated
 - Heat Capacity (specific heat)
 - Thermal Conductivity (isotropic or anisotropic?)
 - Emissivity (typically important above 100C delta between ambient and solids)
 - Density (including a temp/density curve for gasses, driving natural convection)
 - Maximum Material Temperature (usually important for plastics)
- **Ambient Conditions (CFD)**
 - Any known heat transfer coefficients on any surfaces
 - Surrounding environment surface temp and material of surface
 - Forced or natural convection in surrounding environment
 - Min/max environment temp
 - Environment humidity
 - Pressure (vacuum or other)
 - Gas mix (air, nitrogen, etc.)

- **Ambient Conditions (FEA)**

- Any known heat transfer coefficients on any surfaces
- Ambient temperature of surfaces

3. Heater Requirements

Understanding the project’s heater requirements will help us narrow down the product you need. As with Step 2, CFD analyses require much more understanding of the thermal requirements of the heater, and consequently require more data.

- **Thermal Requirements (CFD)**

- Min/max operating temperature
- Maximum safe surface temperatures (in case user touches a hot surface)
- Temperature ramp-up rate (warm up rate)
- Temperature ramp-down rate (cooling rate)
- Warm up time
- Thermal uniformity
- Maximum power available
- Sensor/Controller
- Type of control system
- Type of sensor
- Location of sensor

- **Thermal Requirements (FEA)**

- Min/max operating temperature
- Maximum safe surface temperatures (in case user touches a hot surface)
- Thermal uniformity
- Maximum power available

4. Additional Details

- Technical/Engineering Contact (to be used during simulation setup)
- Justification over real-world testing/experiment
 - Will you save time/cost by comparing early design ideas/iterations without fabrication?
 - Or will real-world testing/fabrication be required for all options either way?
- OPTIONAL: Performance Data for existing/similar design
 - Used to qualify CFD setup and develop transfer functions.

Prototyping with Thermofoil Heaters

Use multiple standard heaters to prototype a profiled heating solution

Create a Mosaic of Heaters

Etched-foil heaters provide excellent temperature control and uniformity in a broad range of applications. Their thin profile and foil elements contribute to fast warm-up, consistent heat distribution, and extended heater life. To achieve ideal performance, however, the heater must be properly configured to the thermal demands of the application. The complex physics of heat transfer makes it difficult to predict all aspects of system performance in the early design stages. Therefore, applications requiring tightly regulated temperature may require extensive prototype work.

Minco offers off-the-shelf stock heaters in a variety of sizes and insulation packages, including polyimide, silicone rubber, mica, optically-clear polyester, or PTFE.

If the size or shape of your heat sink precludes using a single standard heater, you can often construct a mosaic to cover the surface. Grouped etched-foil heaters mimic profiled designs. Simply increase power to certain heaters until temperature stabilizes in the desired pattern. The resulting power settings tell you how to profile the watt density zones in a custom design.

Estimating power distribution

A mosaic of standard heaters, with dual power supplies, helps to determine edge profiling for uniform temperature.

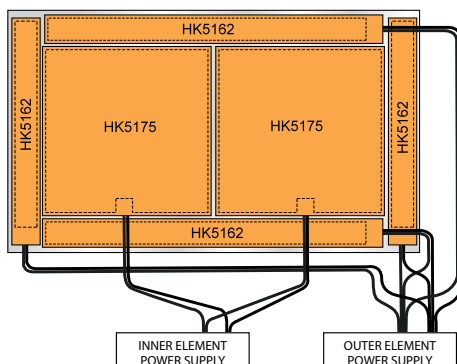

The resulting custom heater looks like this.

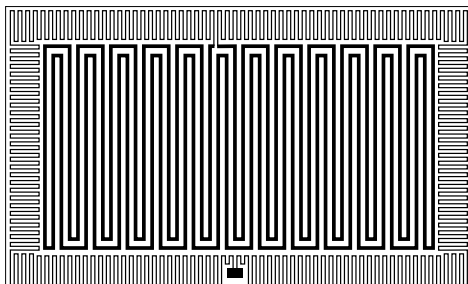

Estimating power requirements

The total amount of power required for an application is the larger of two values:

1. Warm-up power + Heat lost during warm-up
2. Process heat + Heat lost in steady state

Warm-up power: Watts required to bring an object to temperature in a given time. The basic formula is:

$$P(\text{watts}) = \frac{m C_p (T_f - T_i)}{t}$$

where:

m = Mass of object (g)

C_p = Specific heat of material (J/g/°C)

T_f = Final temperature of object (°C)

T_i = Initial temperature of object (°C)

t = Warm-up time (seconds)

Material	Specific heat (J/g/°C)	Density (g/cm ³)
Air	1.00	0.0012
Aluminum	0.88	2.71
Copper	0.38	8.97
Glass	0.75	2.64
Oil (typical)	1.90	0.90
Plastic (typical)	1.25	Varies
Silicon	0.71	2.32
Solder	0.19	8.65
Steel	0.50	7.85
Water	4.19	1.00

For other materials see Minco white paper "Prototyping Techniques for Etched-Foil Heaters" at www.minco.com.

To get: Multiply:
 J/g/°C BTU/lb/°F × 4.19
 g/cm³ lbs/ft³ × 0.016

Process heat: Heat required to process a material when the heater is performing useful work. The formula above also applies here, but must also include latent heat if material changes state (melts or evaporates).

Heat loss: All systems lose heat through convection (air or liquid movement), conduction through support structures, and thermal radiation.

For more tips on designing and testing with Thermofoil heaters, visit the Heaters page on Minco.com.



Heater Types

Heater Types

All-Polyimide (AP) Heaters	19
Mica Thermofoil Heaters	21
Polyimide Thermofoil Heaters	24
Silicone Rubber Thermofoil Heaters	27
Silicone Rubber Wire-Wound Heaters	29
SmartHeat SLT™ Heaters	31
Thermal-Clear™ Transparent Heaters	34

All-Polyimide (AP) Thermofoil Heaters

Flexible heaters provide uniform heat transfer to 260°C (500°F)

Overview

AP heaters are a high performance alternative to Minco's standard polyimide heaters, allowing higher temperatures and watt densities. Minco's unique ability to manufacture these heaters has prompted success in many high-temperature applications worldwide.

AP heaters must be factory mounted or clamped to heat sinks, and are only available as custom designs.

- Thin, lightweight heaters allow you to apply heat where it's needed ultimately reducing overall operating costs
- Etched-foil heating technology provides efficient thermal cycling of samples for increased throughput
- Low mass construction and factory lamination saves space and reduces cycle time
- Custom profiling offers uniform thermal performance of heating output for improved processing yields and productivity
- Maximum operating temperature of 260°C offers a higher temperature range than any other flexible film heater for maximum design flexibility
- Turnkey assembly solutions can drastically reduce assembly time and provide lowest total cost of operation
- Available in round, rectangular, and irregular shapes
- Power ratings to 120 W/in² (18.60 W/cm²)
- Resistant to most chemicals
- Optional built-in temperature sensors
- Contact Customer Sales for design assistance.

Typical applications

- Semiconductor wafer processing
- Heating of electronic components
- Packaging, fusing, and splicing equipment
- Medical diagnostic analyzers

Specifications

Temperature range:

-200 to 260°C (-328 to 500°F).

With UL component recognition:

-200 to 240°C (-328 to 464°F).

Leadwires: Stranded, PTFE insulated, AWG 30 to AWG 20.

Heater thickness:

Over element: 0.012" (0.3 mm) max.

Over leadwire terminations: 0.150" (3.8 mm) ref.



Dielectric strength: 1000 VRMS at 60 Hz for 1 minute.

Insulation resistance: 1000 megohms min. at 500 VDC.

Outgassing: 0.36% total mass loss, 0.01% collected volatile condensable material, per NASA-JSC.

Agency Approvals: UL recognition optional.

Maximum size: 22" x 45" (560 x 1145 mm).

Consult Minco for larger size options.

Maximum resistance density: 1500 Ω/in² (233 Ω/cm²).

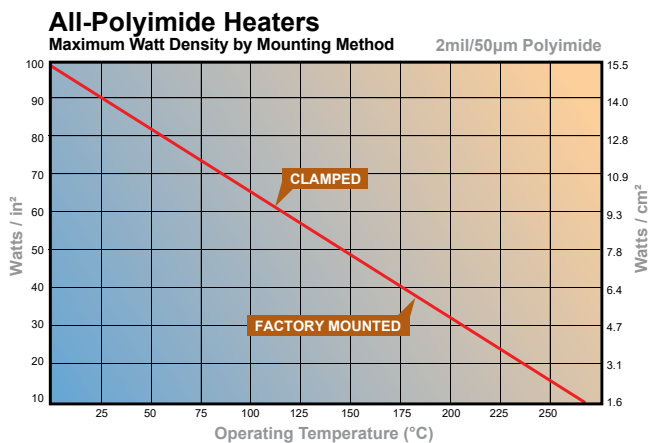

Stock AP Thermofoil Heaters

Buy online at Minco.com

Notes for Stock Heaters

- Heated area is within the X and Y dimensions
- Voltage and wattage values are for reference only
- Resistance tolerance is +/- 10% or +/- 0.5Ω, whichever is greater
- Heaters may be operated at other voltages if they do not exceed the maximum allowable watt density ratings
- Standard leadwire length is 12" (305 mm) minimum
- Type 21 and 30 configurations have lead connections on an external tab, which produces negligible heat, in most cases, does not need to be adhered to the heat sink
- Mounting: must be clamped to heat sinks
- Type (configuration)

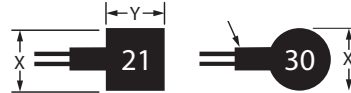

TAB DIMENSIONS:

- AWG 30: 0.25" wide x 0.50" long (6.4 mm x 12.7 mm)
- AWG 26: 0.50" wide x 0.50" long (12.7 mm x 12.7 mm)
- AWG 22: 0.60" wide x 0.60" long (15.2 mm x 15.2 mm)

Size (inches)		Size (mm)		Type	Resistance (Ω)	Typical power		Effective area		Lead AWG	Model number
X	Y	X	Y			Watts	Volts	in ²	cm ²		
0.25	10.00	6.4	254.0	21	24.4	28	32	1.28	0.83	30	HAP6943
0.50	0.50	12.7	12.7	30	37.9	12	4	0.15	0.10	26	HAP6944
0.50	2.00	12.7	50.8	21	40.0	28	20	0.78	0.51	26	HAP6945
0.50	5.00	12.7	127.0	21	15.6	28	50	2.01	1.30	26	HAP6946
1.00	1.00	25.4	25.4	21	37.9	28	21	0.83	0.53	26	HAP6947
1.50	3.00	38.1	76.2	21	7.9	28	99	3.97	2.56	26	HAP6948
3.00	5.00	76.2	127.0	21	39.4	115	336	13.44	8.67	22	HAP6949

Mica Thermofoil Heaters

High watt density and temperature range

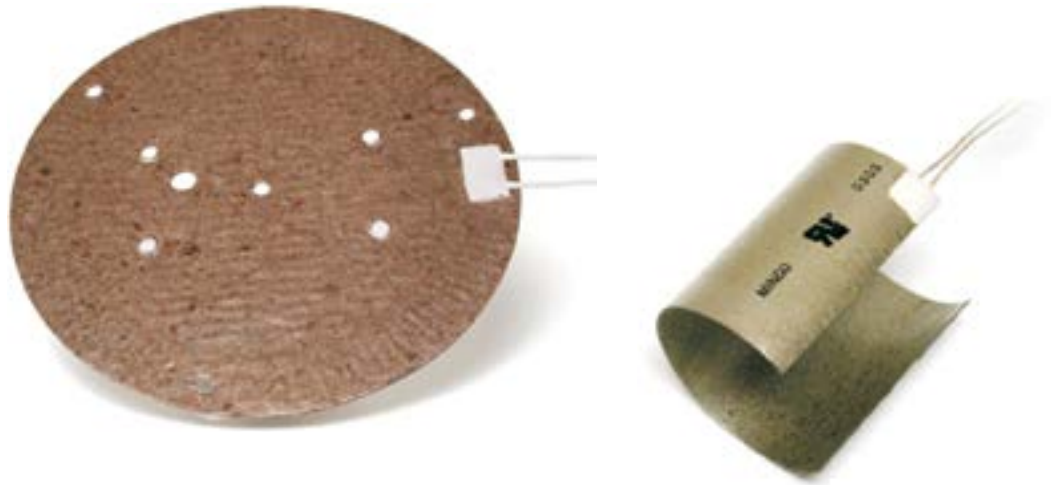

Overview

Mica Thermofoil™ heaters consist of an etched foil element sandwiched between layers of mica. Installed by clamping to heat sinks, mica heaters provide the ultimate temperature and wattage capability for fast warmup.

- Broad temperature range of -150° to 600°C provides faster processing and cycle times for greater production output
- High watt density capability to 110 W/in^2 (17 W/cm^2) provides faster processing times than conventional mica strip heaters
- Custom profiled heat density and mechanical clamping offers uniform heat sink temperature which can improve processing yields
- UL certification is available which can save time and money for end-use UL device recognition
- Can be factory formed to curves
- Heaters are suitable for vacuum use after initial burn-in (see next page)

Typical applications

- Semiconductor processing
- Packaging, strapping, and sealing equipment
- DNA thermocycling
- Food service appliances
- Plastics and rubber molding supplemental heat

Custom options

- Custom shapes and sizes to $22'' \times 46''$ ($560 \times 1168\text{ mm}$)
- Custom resistance options up to 25 W/in^2 (3.9 W/cm^2)
- Factory forming techniques offer three dimensional packaging capabilities
- Integral temperature sensors
- Contact Customer Service for design assistance.



Mica Thermofoil Heaters

Technical specifications

Specifications

Temperature range: -150 to 600°C (-238 to 1112°F).

Lead tab area: 538°C (1000°F) max.

Resistance tolerance: ±10% or ±0.5 Ω, whichever is greater.

Dielectric strength:

0.010" (0.3mm) insulation: 1000 VRMS.

0.020" (0.5mm) insulation: 2000 VRMS (recommended for over 250 V).

Mounting: Must be clamped to heat sink using bolt holes provided in heater and backing plate. See the mounting diagram below. Please refer to Minco Engineering Instruction #347 for detailed installation information.

Burn-in: Organic binders will burn off, producing small amounts of smoke, when heaters are first powered. After this, layers can separate so heaters should not be reinstalled.

Leadwire: Mica/glass insulated, stranded nickel-clad copper, potted over termination with high temperature cement.

Maximum heater thickness:

Mica insulation	Over heater element	Over lead termination
0.010" (0.3 mm)	0.030" (0.8 mm)	0.200" (5.1 mm)
0.020" (0.5 mm)	0.050" (1.3 mm)	0.220" (5.6 mm)

Current capacity (based on 100°C max. ambient temp.):

AWG 22 - 8.0 A

AWG 20 - 9.0 A

AWG 18 - 11.0 A

Installation instructions

Minco Engineering Instruction #347 describes mica heater installation in detail. Contact Minco for a copy or download the document at www.minco.com/

Backing plates

Backing plates are 0.0625" (1.6 mm) thick stainless steel with pre-drilled holes matching the bolt pattern of the specified model. These backing plates do not have cut out areas for the lead bulge and may require modification. Backing plates are available on www.minco.com/

Ceramic paper

Each mica heater is supplied with two pre-trimmed sheets of 0.125" (3.2 mm) thick ceramic fabric paper for use as a resilient pad between the heater and backing plate. This paper does not have a cut out area for the lead bulge. If the backing plate being used does not have a cut out area for the leads attachment you must use two pieces of this paper and make this cut out in each. Contact Minco to order additional ceramic paper.

Mica sheets

Additional layers of 0.010" (0.3 mm) mica trimmed to the heater size are also available. Using an additional layer of mica will increase the dielectric strength, but it will also reduce the watt density limit by up to 50% across the temperature range. If used on the lead bulge side of the heater then the mica must be cut to allow for the ceramic and wires bulge on that side.

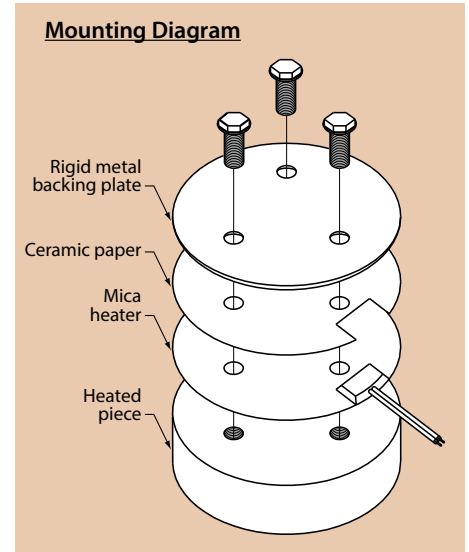

Mica Heaters

Maximum Watt Density with Clamping

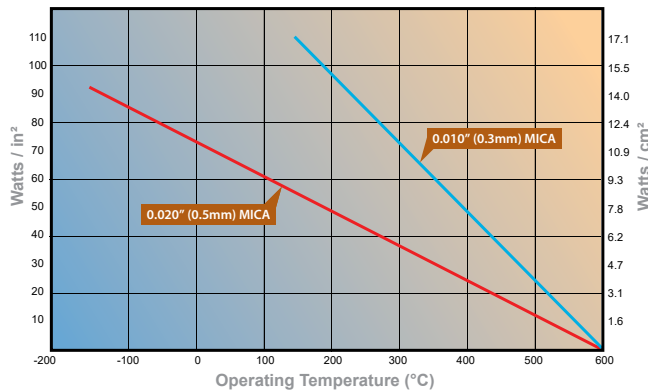

Stock Mica Thermofoil Heaters

Buy online at Minco.com

The stock heaters listed below are available for immediate shipment to support your testing and evaluation.

Notes for Stock Heaters

- Insulation thickness is .010" (0.3 mm)
- Heated area is within the X and Y dimensions
- Resistance tolerance is +/- 10% or +/- 0.5Ω, whichever is greater
- Standard leadwire length is 12" (305 mm) minimum
- Mounting: Clamp to any flat surface either with a clamping mechanism outside the heater area or by using a backing plate and bolt through the pre-punched bolt holes. All heaters come with one piece of matching 0.125" (3 mm) thick ceramic paper for use as a resilient pad on the lead bulge side of the heater. Matching stainless steel backing plates and additional sheets of ceramic paper are also available.

Rectangular heaters

Size (inches)		Size (mm)		Resistance (Ω at 0°C)	Effective Area		Lead AWG	Model Number
X	Y	X	Y		in ²	cm ²		
1.00	4.00	25.4	101.6	11.0	2.5	16.13	22	HM6950
1.00	4.00	25.4	101.6	21.2	2.5	16.13	22	HM6951
1.50	3.00	38.1	76.2	4.5	3.2	20.65	22	HM6952
1.50	3.00	38.1	76.2	8.7	3.2	20.65	22	HM6953
2.00	2.00	50.8	50.8	12.0	2.8	18.06	22	HM6954
2.00	2.00	50.8	50.8	23.2	2.8	18.06	22	HM6955
2.00	4.00	50.8	101.6	6.0	5.9	38.06	18	HM6956
2.00	4.00	50.8	101.6	11.6	5.9	38.06	18	HM6957
2.00	6.00	50.8	152.4	21.9	9.2	59.35	20	HM6958
2.00	6.00	50.8	152.4	42.3	9.2	59.35	20	HM6959
2.00	8.00	50.8	203.2	24.0	12.6	81.29	18	HM6960
2.00	8.00	50.8	203.2	46.3	12.6	81.29	18	HM6961
3.00	3.00	76.2	76.2	31.0	6.5	41.94	20	HM6962
3.00	3.00	76.2	76.2	59.8	6.5	41.94	20	HM6963
6.00	6.00	152.4	152.4	22.0	31.9	205.81	18	HM6964
6.00	6.00	152.4	152.4	42.5	31.9	205.81	18	HM6965
8.00	8.00	203.2	203.2	22.0	58.3	376.13	18	HM6966
8.00	8.00	203.2	203.2	42.5	58.3	376.13	18	HM6967

Round heaters

Diameter (inches)	Diameter (mm)	Resistance (Ω at 0°C)	Effective Area		Lead AWG	Model Number
			in ²	cm ²		
1.50	38.1	2.0	1.2	7.74	22	HM6968
1.50	38.1	3.9	1.2	7.74	22	HM6969
2.00	50.8	9.5	2.2	14.19	22	HM6970
2.00	50.8	18.3	2.2	14.19	22	HM6971
3.00	76.2	11.1	5.4	34.84	20	HM6972
3.00	76.2	21.4	5.4	34.84	20	HM6973
4.00	101.6	40.0	10.0	64.52	18	HM6974
4.00	101.6	77.2	10.0	64.52	18	HM6975
6.00	152.4	32.7	24.7	159.35	18	HM6976
6.00	152.4	63.1	24.7	159.35	18	HM6977



Polyimide Thermofoil Heaters

Thin, flexible heating solutions from -200 to 200°C

Overview

- Polyimide (Kapton™) is a thin, semitransparent material with excellent dielectric strength. Polyimide Thermofoil™ heaters are ideal for applications with space and weight limitations, or where the heater will be exposed to vacuum, oil, or chemicals.
- The lightweight heater has less thermal mass to improve thermal response
- The thin profile with nearly infinite custom X-Y geometry design options allows you to apply heat where it's needed, reducing operating costs
- Etched-foil heating technology provides fast and efficient thermal transfer
- Customized options (i.e. SMT components, flex leads and connectors) offer turnkey solutions to drastically reduce assembly time and increase productivity
- Custom profiling gives uniform thermal performance of the heating output to improve processing yields and productivity
- UL and TUV component recognition available
- Suitable for vacuum environments (NASA-RP-1061)
- NASA approved materials for space applications (S-311-P-079)
- Resistant to most chemicals: acids and solvents
- Radiation resistant to 106 rads if built with polyimide-insulated leadwire (custom option)
- Very small sizes available
- Fluid immersible designs available (not standard)
- Optional built-in temperature sensors

Mounting Methods

- #12 PSA with aluminum backing
- Acrylic PSA with or without aluminum backing
- #15 epoxy
- BM3 shrink band
- Stretch tape
- Mechanical clamping



Typical applications

- Medical diagnostic instruments and analyzers
- Maintain warmth of satellite components
- Protect aircraft electronic and mechanical devices against cold at high altitudes
- Stabilize optoelectronic components
- Test or simulate integrated circuits
- Enable cold weather operation of outdoor electronics such as card readers, LCDs or ruggedized laptops
- Maintain constant temperature in analytic test equipment

Options

- Shapes and sizes up to 22" x 72" (560 x 1825 mm)
- Resistance up to 1500 Ω /in² (233 Ω /cm²)
- WA, ULA, or FEP (UL recognized) internal adhesive
- Available with surface mount sensors, connectors, heat sinks and even integral controllers
- TÜV or UL recognition marking is optional
- RoHS compliance

Polyimide Thermofoil Heaters

Technical specifications

Specifications

Temperature range: -200 to 200°C (-328 to 392°F). Upper limit with 0.003" (0.08 mm) foil backing is 150°C (302°F).

Material: 0.002" Polyimide/0.001" adhesive (0.05/0.03 mm).

Resistance tolerance: $\pm 10\%$ or $\pm 0.5 \Omega$, whichever is greater.

Dielectric strength: 1000 VRMS.

Minimum bend radius: 0.030" (0.8 mm).

Leadwire: Red PTFE insulated, stranded.

Current capacity (based on 100°C max. ambient temp.):

AWG 30 - 3.0 A

AWG 26 - 5.0 A

AWG 24 - 7.5 A

AWG 20 - 13.5 A

Maximum heater thickness:

Over element 0.012" (0.3 mm)

Over leads

AWG 30 (0.057 mm²) 0.050" (1.3 mm)

AWG 26 (0.141 mm²) 0.060" (1.5 mm)

AWG 24 (0.227 mm²) 0.065" (1.7 mm)

AWG 20 (0.563 mm²) 0.085" (2.2 mm)

Add 0.005" (0.1 mm) to above dimensions for foil backing.

Dimensional tolerance:

6" (150 mm) or less $\pm 0.03"$ (± 0.8 mm)

6.01 to 12" (150 to 300 mm) $\pm 0.06"$ (± 1.5 mm)

Over 12" (300 mm) $\pm 0.12"$ (± 3.0 mm)

Tighter tolerances are available on custom designs if needed.

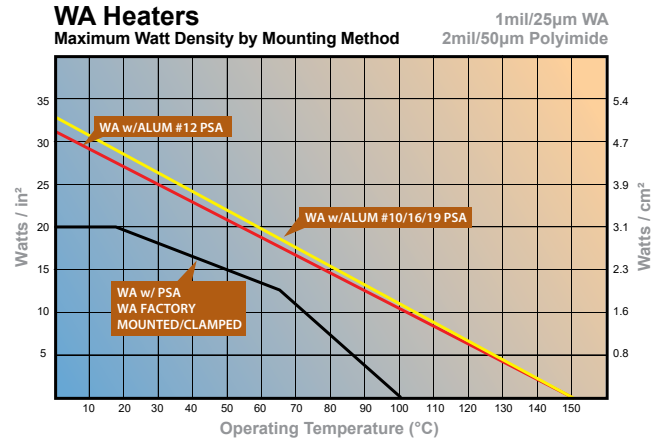

Stock Polyimide Thermofoil Heaters

Buy online at Minco.com

Notes for Stock Heaters

- Heated area is within the X and Y dimensions
- Voltage and wattage values are for reference only
- Resistance tolerance is +/- 10% or +/- 0.5Ω, whichever is greater
- Heaters may be operated at other voltages if they do not exceed the maximum allowable watt density ratings
- Thermoset acrylic internal adhesive (not UL recognized)
- Standard leadwire length is 12" (305 mm) minimum
- Type 21 configurations have lead connections on an external tab, which produces negligible heat, in most cases, does not need to be adhered to the heat sink

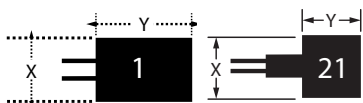

Sized (inches)		Size (mm)		Type	Resistance (Ω)	Typical power		Effective area		Lead AWG	Model number
X	Y	X	Y			Watts	Volts	in ²	cm ²		
0.50	1.00	12.7	25.4	21	210.1	4	28	0.37	0.24	26	HK6900
0.50	2.00	12.7	50.8	30	100.1	8	28	0.78	0.51	26	HK6901
0.50	3.00	12.7	76.2	21	65.7	12	28	1.19	0.77	26	HK6902
0.50	4.00	12.7	101.6	21	48.9	16	28	1.60	1.03	26	HK6903
0.50	5.00	12.7	127.0	21	38.9	20	28	2.01	1.30	26	HK6904
0.50	10.00	12.7	254.0	21	19.3	41	28	4.06	2.62	26	HK6905
1.00	1.00	25.4	25.4	21	94.7	8	28	0.83	0.53	26	HK6906
1.00	2.00	25.4	50.8	1	47.8	16	28	1.64	1.06	26	HK6907
1.00	3.00	25.4	76.2	1	32.1	24	28	2.44	1.58	26	HK6908
1.00	4.00	25.4	101.6	1	23.6	33	28	3.32	2.14	26	HK6909
1.00	5.00	25.4	127.0	1	18.7	42	28	4.20	2.71	26	HK6910
2.00	2.00	50.8	50.8	1	22.1	36	28	3.55	2.29	26	HK6911
2.00	3.00	50.8	76.2	1	14.7	53	28	5.32	3.43	26	HK6912
2.00	4.00	50.8	101.6	1	187.6	70	115	7.05	4.55	22	HK6913
2.00	5.00	50.8	127.0	1	157.1	84	115	8.42	5.43	22	HK6914

Silicone Rubber Thermofoil Heaters

Rugged and flexible to 235°C

Overview

Silicone rubber is a rugged, flexible elastomer material with excellent temperature properties. It is most suited to larger heaters and industrial applications.

- Rugged construction provides high reliability in a wide range of heating applications
- Optional custom profiled heat density creates a uniform heat sink temperature which can improve processing yields
- Factory vulcanization and high temperature capability allows higher wattage levels for faster processing
- High temperature capability to 235°C (455°F)
- UL and TÜV component recognition available
- Resistant to many chemicals
- Not suitable for radiation, vacuum, or prolonged exposure to oil
- Most economical in large sizes

Typical applications

- Thermal developing in graphic imaging equipment
- Prevent condensation in instrument cabinets
- Heat outdoor electronics
- Food service equipment
- Medical respirators
- Laminators
- Drums and other vessels
- Airplane engine heaters

Custom options

- Custom shapes and sizes to 22" × 90" (560 × 2285 mm)
- Custom resistance to 200 W/in² (31 W/cm²)
- Minco can factory vulcanize rubber heaters to metal shapes for best economy and performance
- Heaters can have integral snaps, straps, or Velcro® for removable installation
- Heaters can include thermostats, temperature sensors and cutouts, wiring harnesses, and connectors
- RoHS compliance
- Contact Customer Service for design assistance



Specifications

Temperature range: -45 to 235°C (-50 to 455°F).
With UL component recognition: -45 to 220°C (-50 to 428°F).

Material: Fiberglass reinforced silicone rubber, 0.008" (0.20 mm).

Resistance tolerance: ±10% or ±0.5 Ω, whichever is greater.

Dielectric strength: 1000 VRMS.

Minimum bend radius: 0.125" (3.2 mm).

Leadwire: Red PTFE insulated, stranded.

Current capacity (based on 100°C max. ambient temp.):

AWG 30 - 3.0 A	AWG 24 - 7.5 A
AWG 26 - 5.0 A	AWG 20 - 13.5 A

Maximum heater thickness:

	No adhesive (A):	#12 PSA (B):
Over element	0.020" (0.5 mm)	0.025" (0.6 mm)

Over leads

AWG 30 (0.057 mm ²)	0.070" (1.8 mm)	0.085" (2.2 mm)
AWG 26 (0.141 mm ²)	0.080" (2.0 mm)	0.095" (2.4 mm)
AWG 24 (0.227 mm ²)	0.090" (2.3 mm)	0.105" (2.7 mm)
AWG 20 (0.563 mm ²)	0.120" (3.0 mm)	0.135" (3.4 mm)

Add 0.005" (0.1 mm) to above dimensions for foil backing.

Dimensional tolerance:

6" (150 mm) or less	±0.03" (±0.8 mm)
6.01 to 12" (150 to 300 mm)	±0.06" (±1.5 mm)
Over 12" (300 mm)	±0.12" (±3.0 mm)

Tighter tolerances are available on custom designs if needed.



Stock Silicone Rubber Thermofoil Heaters

Buy online at Minco.com

Notes for Stock Heaters

- Heated area is within the X and Y dimensions
- Voltage and wattage values are for reference only
- Resistance tolerance is +/- 10% or +/- 0.5Ω, whichever is greater
- Heaters may be operated at other voltages if they do not exceed the maximum allowable watt density ratings
- Leadwire length is 12" (305 mm) minimum
- Type 30 configurations have lead connections on an external tab, which produces negligible heat, in most cases, does not need to be adhered to the heat sink
- Use of Acrylic PSA caps the heaters at 150°C max operating temp
- Mounting: Acrylic PSA with foil backing is applied on entire substrate area (including external tab if applicable)
- Temperature range -32°C to 150°C

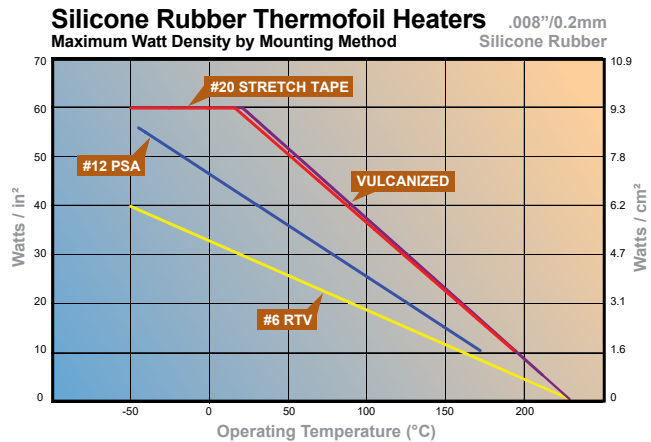

Stock silicone rubber Thermofoil heaters

Sized (inches)		Size (mm)		Type	Resistance (Ω)	Typical power		Effective area		Lead AWG	Model number
X	Y	X	Y			Watts	Volts	in ²	cm ²		
2.00	2.00	50.8	50.8	1	22.8	34	28	3.43	2.22	24	HR6925
2.00	2.00	50.8	50.8	30	27.4	29	28	2.87	1.85	24	HR6939
2.00	3.00	50.8	76.2	1	14.8	53	28	5.31	3.43	24	HR6926
2.00	6.00	50.8	152.4	1	127.9	103	115	10.34	6.67	24	HR6927
2.00	8.00	50.8	203.2	1	94.9	139	115	13.94	8.99	24	HR6928
2.00	10.00	50.8	254.0	1	75.4	175	115	17.54	11.32	24	HR6929
3.00	3.00	76.2	76.2	1	161.4	82	115	8.19	5.29	24	HR6930
3.00	3.00	76.2	76.2	30	11.8	67	28	6.65	4.29	24	HR6940
3.00	4.00	76.2	101.6	1	119.4	111	115	11.07	7.14	24	HR6931
3.00	5.00	76.2	127.0	1	99.1	133	115	13.34	8.61	24	HR6932
3.00	6.00	76.2	152.4	1	81.9	161	115	16.14	10.41	24	HR6933
4.00	4.00	101.6	101.6	1	88.4	150	115	14.95	9.65	24	HR6934
4.00	5.00	101.6	127.0	1	72.9	181	115	18.14	11.70	24	HR6935
4.00	6.00	101.6	152.4	1	60.3	219	115	21.94	14.15	24	HR6936
5.00	5.00	127.0	127.0	1	57.7	229	115	22.94	14.80	24	HR6937
5.00	8.00	127.0	203.2	1	35.4	373	115	37.34	24.09	24	HR6938

Silicone Rubber Wire-Wound Heaters

Uniform heating to 220°C

Overview

- These silicone rubber heaters have a wire-wound element and are economical in large sizes.
- Mean time between failure (MTBF) of 100,000 hours+ provides longer heater life under continuous operation
- Rugged construction and high ductility allows repeated flexing for easier installation
- Element wires sealed inside silicone rubber protects electrical connections from moisture preventing costly downtime for field repairs
- Uniform heating to 220°C (428°F) 235°C (220 for UL)
- Heater lengths to 90" (1.8 m)
- Mount to flat or curved surfaces
- 2.5, 5, 10, 15 watts/in² (0.39, 0.78, 1.55, 2.33 watts/cm²) at 120 or 240 VAC
- Lower leakage current due to reduce capacitive coupling

Typical Applications

- Prevent condensation in motors and generators
- Protect instrument cabinets from cold and humidity
- De-icing
- Control fluid viscosity in valves and vessels
- Industrial ovens and thermal processing equipment
- Platens
- Medical devices

Options

- Shapes and sizes to 22" × 90" (560 × 2285 mm)
- Resistance to 150 Ω/in²
- TÜV and UL component recognition marking are available
- Heaters can include thermostats, temperature sensors and cutouts, wiring harnesses, and connectors
- RoHS compliance



Specifications

- **Temperature range:** -45 to 235°C (-50 to 455°F). With UL component recognition: -45 to 220°C (-50 to 428°F).
- **Overall Thickness:** 0.055" ±0.005" (1.4 ±0.13 mm). 0.250" (6.4 mm) maximum over leadwires.
- **Maximum voltage rating:** UL rating is 600 VAC, TÜV recognition up to 250 VAC.
- **Leadwires:** AWG 20 except where noted, PTFE insulated per UL 1199/CSA. Length on standard models is 12" (305 mm).
- **Current capacity** (based on 100°C max. ambient temp.):
AWG 20 - 13.5 A
AWG 18 - 16.0 A
- **Approvals:** Can be configured to comply with UL Standard 499 and Canadian Standard C22.2, No. 72-M1984 and European Standard EN60335 and may bear the corresponding recognition marks.
- **Wattage tolerance:** ±5%.

Stock Silicone Rubber Wire-Wound Heaters

Buy online at Minco.com

Notes for Stock Heaters

- Heated area is within the X and Y dimensions
- Voltage and wattage values are for reference only
- Resistance tolerance is +/- 10% or +/- 0.5Ω, whichever is greater
- Heaters may be operated at other voltages if they do not exceed the maximum allowable watt density ratings
- Leadwire length is 12" (305 mm) minimum
- Mounting: no adhesive mounting supplied
- TUV and UL component recognition marking are standard

120 Volt

Size (inches)		Size (mm)		Volts	Watts	Model number
X	Y	X	Y			
1	6	25.4	152.4	120	30	HR6870A
1	10	25.4	254.0	120	25	HR6877A
1	10	25.4	254.0	120	50	HR6850A
1	12	25.4	304.8	120	60	HR6871A
1	20	25.4	508.0	120	50	HR6878A
1	20	25.4	508.0	120	100	HR6852A
1	24	25.4	609.6	120	120	HR6873A
1	30	25.4	762.0	120	75	HR6880A
1	30	25.4	762.0	120	150	HR6854A
1	40	25.4	1016.0	120	100	HR6882A
1	40	25.4	1016.0	120	200	HR6856A
1	60	25.4	1524.0	120	150	HR6884A
1	60	25.4	1524.0	120	300	HR6858A
2	10	50.8	254.0	120	100	HR6860A
2	20	50.8	508.0	120	100	HR6886A
2	20	50.8	508.0	120	200	HR6862A
2	24	50.8	609.6	120	240	HR6875A
2	30	50.8	762.0	120	150	HR6888A
2	30	50.8	762.0	120	300	HR6864A
2	40	50.8	1016.0	120	200	HR6890A
2	40	50.8	1016.0	120	400	HR6866A
2	60	50.8	1524.0	120	600	HR6868A

240 Volt

Size (inches)		Size (mm)		Volts	Watts	Model number
X	Y	X	Y			
1	10	25.4	254.0	240	50	HR6851A
1	12	25.4	304.8	240	60	HR6872A
1	20	25.4	508.0	240	50	HR6879A
1	20	25.4	508.0	240	100	HR6853A
1	24	25.4	609.6	240	120	HR6874A
1	30	25.4	762.0	240	75	HR6881A
1	30	25.4	762.0	240	150	HR6855A
1	40	25.4	1016.0	240	100	HR6883A
1	40	25.4	1016.0	240	200	HR6857A
1	60	25.4	1524.0	240	150	HR6885A
1	60	25.4	1524.0	240	300	HR6859A
2	10	50.8	254.0	240	100	HR6861A
2	20	50.8	508.0	240	100	HR6887A
2	20	50.8	508.0	240	200	HR6863A
2	24	50.8	609.6	240	240	HR6876A
2	30	50.8	762.0	240	150	HR6889A
2	30	50.8	762.0	240	300	HR6865A
2	40	50.8	1016.0	240	200	HR6891A
2	40	50.8	1016.0	240	400	HR6867A
2	60	50.8	1524.0	240	600	HR6869A

SmartHeat SLT™ Heaters

Minco's self-limiting heaters require no sensor or controller

Overview

SmartHeat is the ideal solution for many of today's most demanding heating applications. It provides a plug-and-play heating solution requiring only a power source. Each heater operates to a specific temperature and power based on its unique design. The heating power is applied and modulated at infinite points across the entire heating surface based on the heat load. This allows the heater to provide the required power, up to but never exceeding the designed temperature.

SmartHeat Technology

SmartHeat™ technology consists of a thin silicone matrix loaded with conductive carbon particles. Electrical current moves between the carbon particles via quantum tunnelling of electrons through the non-conductive silicone material. The spacing of the carbon particles determines electrical resistance of the material and the current it can carry at any point. As the silicone warms, thermal expansion drives the carbon particles farther apart and increases resistance point-by-point over the surface of the heater. At the designed set-point temperature the heater effectively becomes an electrical isolator, drawing negligible current, and no longer producing heat. Conversely, if the silicone cools via environmental or load variations, the carbon particles pull closer together, reducing resistance. This allows a localized current-flow increase and the heater produces more heat at that location in order to maintain thermal equilibrium.

These effects drive the self-limiting nature of this technology without the need for external instrumentation and control systems. By controlling the composition of the carbon-silicone matrix in production, the the heater is designed to approach, but not exceed, a specific temperature set point. When a heater is powered, it warms to its designed set point and maintains that temperature within a narrow band.



Applications

Many applications can benefit from the simplicity and reliability of SmartHeat. Some examples include:

- Keeping batteries warm and condensation-free for maximum output
- Humidifying respiratory equipment for patient safety and comfort
- Safe storage of reagents for accurate analysis
- Defrosting of displays for clarity and readability
- Defrosting LEDs for safe, clear lighting
- Deicing infrared lenses for reliable signaling
- Sensor anti-icing for effective function
- Valve warming to maintain liquid flow
- Low-weight deicing of aircraft wings for safe, reliable operation

SmartHeat Resources

Learn more about SmartHeat technology on Minco.com:

- SmartHeat white paper
- SmartHeat FAQ
- Webinar



SmartHeat SLT Heaters

Technical specifications

Specifications

Environment temperature range: -45°C (-49°F) to 100°C (212°F)

Operational set point range: 10°C (50°F) to 70°C (158°F)

Leadwires: 24 AWG

Lot/Batch Variation: +/- 5decC typical

Heater Size Constraint: 7 in x 22 in Maximum (standard construction)

22 in x 42 in Maximum (stitched construction)

Heater thickness: 0.018 in

Features & Benefits

- No risk of overheating due to delamination or environmental changes
- Automated, elevated temperature management and control with consistent thermal outcomes
- Patented materials ensure peak performance in a thin implicit control simplifies device design and reduces product launch cycle

Stability

- From a cold start, SmartHeat initially provides maximum power to quickly reach its designated operating temperature. As it approaches the operating temperature it will sharply reduce power output and slow heating.
- When the operating temperature is reached, SmartHeat provides only the power required to maintain thermal equilibrium, eliminating any temperature overshoot. Once thermal equilibrium is achieved, SmartHeat responds to any changes in the environment to maintain the operating temperature across the entire device surface. The heater will adjust power output as necessary at each point across its surface to maintain uniform temperature.
- A traditional heater, where power output is typically controlled by a single sensor feedback loop, is unable to compensate for localized transient variations and can lead to non-uniform temperatures.



Safety

SmartHeat is self-limiting, meaning it can never exceed the designed safety temperature. This is particularly important in applications in which overheating can damage equipment or impair the operation of the system.

It prevents damage due to heater delamination or drastic changes in environmental heat loads. If a heater becomes delaminated, a traditional heater would over-temp and either create a hot spot or drive to failure. The SmartHeat material on the other hand will simply lower the power output to the delaminated area and maintain its set-point.

This is also true for drastic changes in environmental conditions, such as a sudden loss of liquid in a heated container. If a traditional heater encountered an empty or partially empty container or vessel the reduced heat loss from the heated surface may not be adequate, causing the traditional heater to overheat. This will not happen with the SmartHeat material. It will lower its power output and maintain its design set point.

Loss of heating function can also be risky. Unlike a traditional heater, a damaged SmartHeat heater is unlikely to be completely shut down by physical damage. In most cases physical damage will only shut down the damaged area of the heater, allowing it to continue functioning at a reduced level. In some cases, the functioning area will draw increased power to compensate for the damaged area, which does not heat. Overall, SmartHeat is the better choice for applications in which both heater failure and overheating must be avoided.

Stock SmartHeat SLT Heaters

Buy online at Minco.com

The stock heaters listed below are available for immediate shipment to support your testing and evaluation.

Notes for Stock Heaters:

- SmartHeat SLT heaters prevent thermal runaways and overtemp conditions
- Patented innerlay polymer self-tunes to load changes to ensure temperature uniformity
- Inherent control reduces or eliminates the need for external regulating electronics
- Thin, lightweight construction provides heat application where it's needed
- Heat, sense, and control in a single package reduces total system cost

Listed control temperatures and safety temperatures are valid for applications with low thermal loading, at the prescribed nominal voltage setting. Applications with high thermal loading or unique environments should be verified experimentally. Contact Minco to get started.



Size (Inches)		Dia (inches)	Weight (oz.)	Thickness	Control Temp (°C)	Safety Temp Ref (°C)	Lead AWG	Nominal Voltage (V)	Suggested Voltage Range (V)	Model number
X	Y									
2.00	3.00		0.176	0.018	40-60	80	24	12	6-24	HL6500
2.00	3.00		0.176	0.018	40-60	80	24	120	60-240	HL6502
4.00	6.00		0.352	0.018	40-60	80	24	12	6-24	HL6506
4.00	6.00		0.352	0.018	40-60	80	24	48	24-96	HL6507
4.00	6.00		0.352	0.018	40-60	80	24	120	60-240	HL6508
1.00	16.00		0.320	0.018	40-60	80	24	12	6-24	HL6512
1.00	16.00		0.320	0.018	40-60	80	24	48	24-96	HL6513
1.00	16.00		0.320	0.018	40-60	80	24	120	60-240	HL6514
		3.00	0.192	0.018	40-60	80	24	12	6-24	HL6518
		3.00	0.192	0.018	40-60	80	24	48	24-96	HL6519
		3.00	0.192	0.018	40-60	80	24	120	60-240	HL6520
2.00	3.00		0.176	0.018	40-60	80	24	48	24-96	HL6501



Thermal-Clear™ Transparent Heaters

Perfect for de-icing and de-fogging transparent materials

Overview

Featuring a micro-thin wire heating element laid in a pattern between optical grade polyester sheets, Thermal-Clear™ heaters provide reliable heat without blocking light.

- Custom heater element routing and profiling optimizes the visual clarity of the LCD and prevents “shadowing”
- Tight resistance tolerance provides constant and repeatable wattage output for longer battery life
- Low mass and high watt density offers faster warm up time needed for immediate LCD response in cold weather operation
- Rugged materials prevent costly damage during installation and handling
- Integral temperature sensors optional
- Rectangular, round, or irregular shapes
- Uniform or profiled heat patterns

Applications

- Cockpit displays
- Ruggedized computers
- Portable military radios
- Handheld terminals
- Outdoor card readers
- Portable and vehicular computers
- Camera lens deicing
- Defogging windows in environmental chambers
- Heating microscope stages

Custom options

- Integral RTD or thermistor sensors
- Flex circuit terminations
- Rigid materials
- Custom shapes and sizes to 11" x 22" (280 x 560 mm)
- RoHS compliance
- Contact Customer Service for design assistance

Thermal-Clear heaters and LCDs

Most dot matrix LCDs lose sharpness and response speed below 0°C. Achieve acceptable performance at much colder temperatures with a Minco Thermal-Clear heater. 1-2 Ω/in^2 ($0.16 - 0.31 \Omega/\text{cm}^2$) will keep a typical LCD operating properly in ambients as low as -55°C.

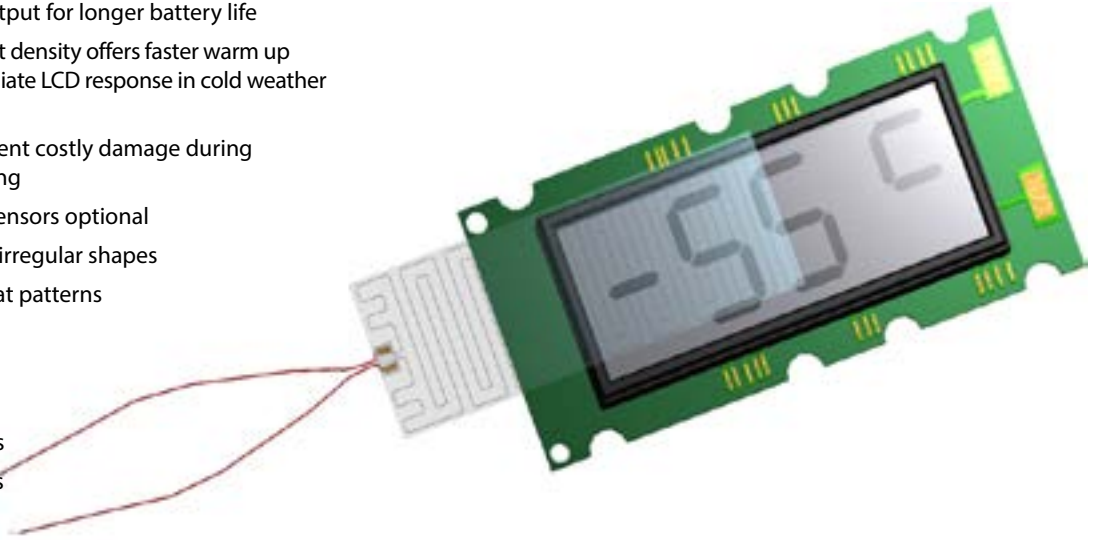

Thermal-Clear™ Heaters
Maximum Watt Density with Acrylic PSA

2mil/50 μm Polyester
2mil/50 μm Adhesive

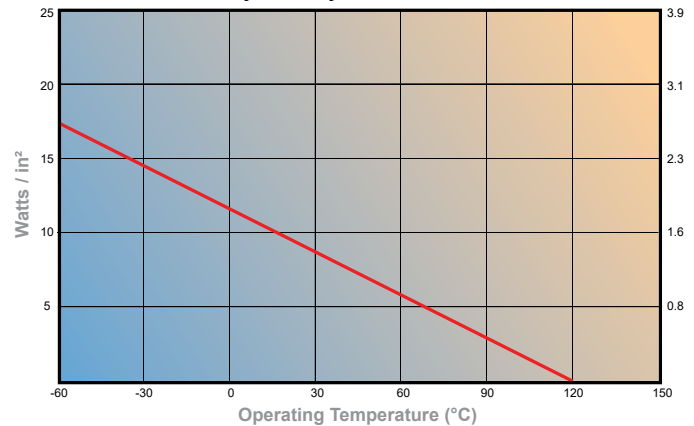

Thermal-Clear Transparent Heaters

Technical specifications

Specifications

Temperature range: -55 to 120°C (-67 to 248°F).

Insulation: Optical grade polyester is standard. Glass and polycarbonate materials are available on custom models.

Transparency: 82% minimum light transmission over the visible spectrum.

Heating element: Resistive wire, diameter 0.0008" to 0.002" (0.02 to 0.05 mm).

Resistance tolerance: ±10% or ±0.5 Ω, whichever is greater.

Leadwires: PTFE insulated wire is standard. Lead connections are welded and anchored between heater layers for strength. Special terminations are available on custom models.

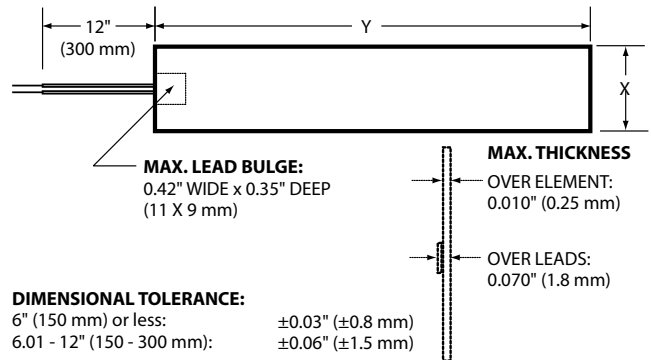

Shown below is a typical installation on a backlit LCD. The heater is sandwiched between the backlight and the LCD. We recommend a light diffuser between the heater and LCD if there is no diffusion coating on the back of the LCD. Diffusion will soften and conceal shadows cast by the heating element.

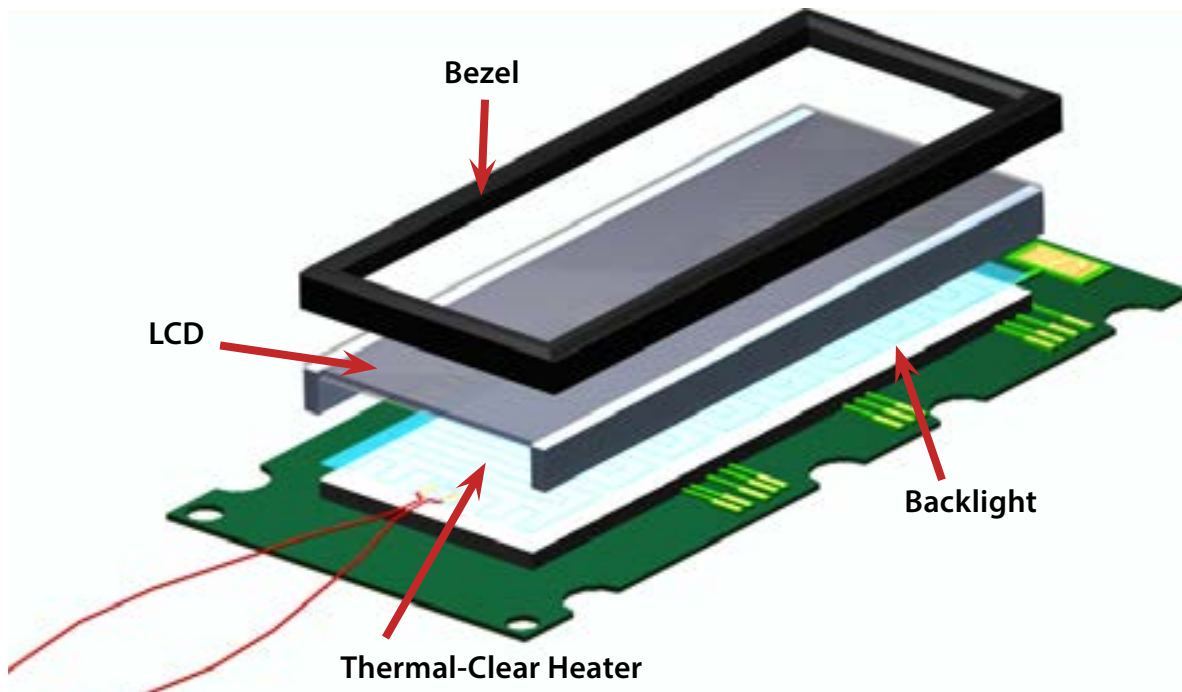

Stock Thermal-Clear Transparent Heaters

Buy online at Minco.com

Notes for Stock Heaters

- Heated area is within the X and Y dimensions
- Resistance tolerance is +/- 10% or +/- 0.5Ω, whichever is greater
- Standard leadwire length is 12" (305mm) minimum
- Mounting: Mechanical clamping (not included)

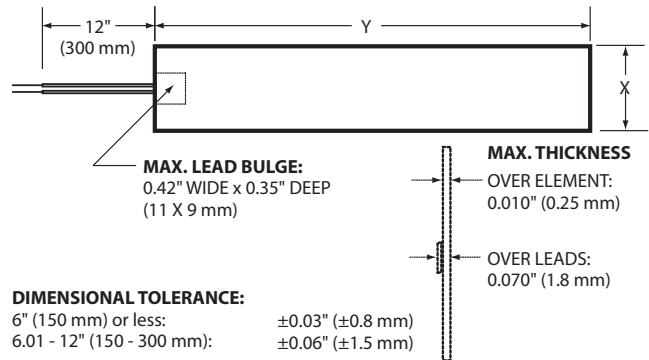

Sized (inches)		Size (mm)		Type	Resistance (Ω)	Typical power		Effective area		Lead AWG	Model number
X	Y	X	Y			Watts	Volts	in ²	cm ²		
0.58	2.20	14.60	55.90	1	89.4	1.6	12	0.80	5.13	30	H6985
0.75	4.00	19.10	101.60	1	22.0	6.5	12	2.35	15.16	30	H6986
0.90	5.75	22.90	146.00	1	14.1	10.2	12	4.29	27.68	30	H6987
1.10	4.40	27.90	111.80	1	30.0	19.2	24	4.09	26.39	30	H6988
1.20	3.65	30.50	92.70	1	101.0	7.8	28	3.71	23.94	30	H6989
2.90	5.75	73.70	146.00	1	9.6	60.0	24	15.55	100.32	30	H6990
4.00	5.00	101.60	127.00	1	31.2	41.5	36	18.83	121.48	30	H6991
0.60	2.35	15.24	59.69	1	240.0	2.4	24	0.95	6.13	30	H6992
0.60	2.85	15.24	72.39	1	192.0	3.0	24	1.19	7.68	30	H6993
1.00	3.35	25.40	85.09	1	96.0	6.0	24	2.62	16.90	30	H6994

Heater Accessories

Thermostats	38
Pre-Cut Insulators	49

Heater Accessories

Select Thermostats and Insulators for your heaters

Thermostats

Thermostats provide basic heater control at little cost. You can also use them as thermal cutoffs in conjunction with other control systems. All thermostats come with a 1.5" (38.1 mm) long, silicone rubber coated sleeve for electrical insulation (case is electrically live), and mounting adhesive.

These thermostats are ordered separately. For information on ordering heaters with factory installed thermostats contact Access: Minco Sales and Support.

Specifications

Stock models:

TH100 creep action, 120 VAC maximum.

TH200 snap action, 240 VAC maximum.

Setpoint tolerance: $\pm 5^{\circ}\text{C}$ ($\pm 9^{\circ}\text{F}$).

Contact configuration: Normally open (NO) above setpoint.

Open/close differential: 5 to 10°C , typical.

Maximum current:

Model TH100: 6 amps at 120 VAC;

8 amps at 12 VDC;

4 amps at 24 VDC.

Model TH200: 4 amps at 240 VAC.

Life rating: 100,000 cycles.

Approvals: UL, CSA.

Specification options

TH100	Model number: TH100 (creep action)
T40	Setpoint options in $^{\circ}\text{C}$ ($^{\circ}\text{F}$): 5 (41), 20 (68), 40 (104), 60 (140), 80 (176), 100 (212), 150 (302), 200 (392)
TH100T40 = Sample part number	

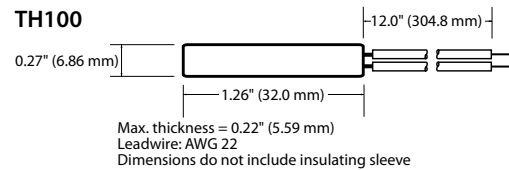

TH200	Model number: TH100 (creep action)
T80	Setpoint options in $^{\circ}\text{C}$ ($^{\circ}\text{F}$): 60 (140), 80 (176), 100 (212), 150 (302)
TH200T80 = Sample part number	

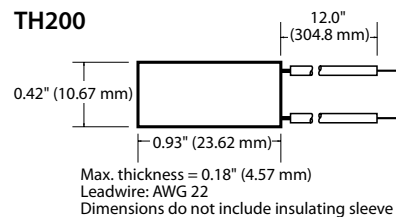

Pre-cut Insulators

Trimmed to the same size as heaters, these pads provide thermal insulation to minimize heat loss. You can also place them between clamping plates and heaters for uniform pressure. Optional pressure sensitive adhesive (PSA) backing permits easy installation. It will not bond permanently and may be removed later without damaging the heater.

* Every mica heater comes with two sheets of ceramic paper free of charge. Order extra sheets here.



Pre-cut insulator
Heater
Heat sink

Material °C×m/W	Thickness	Temperature limit		R factor Uncompressed
		with PSA	no PSA	
Neoprene	0.125" (3.18 mm)	107°C	107°C	23.1 °C×m/W
Silicone rubber foam	0.125" (3.18 mm)	204°C	204°C	9.2 °C×m/W
Mica	0.010" (0.25 mm)	N/A	600°C	2.5 °C×m/W
Ceramic paper*	0.125" (3.18 mm)	N/A	600°C	11.5 °C×m/W

You can estimate heat loss with the following formula:

$$\text{Heat loss (W)} = \frac{A (T_f - T_a)}{1000 RL}$$

where:

- W = Watts of heat lost through insulation
- A = Heater area in square mm
- T_f = Heat sink temperature in °C
- T_a = Ambient temperature in °C
- R = R factor in °C × m/W
- L = Thickness of insulation in mm

Specification options

IN	IN = Insulating pad
5334	Matching heater model number
N1	Material: N1 = Neoprene R1 = Silicone rubber M1 = Mica C1 = Ceramic paper
B	Pressure sensitive adhesive: A = No PSA B = With PSA backing (N/A with ceramic or mica)
IN5334N1B = Sample part number	



Sensors and Controllers







Temperature Sensors	41
Temperature Controllers	42
CT325 Miniature DC Temperature Controllers.....	43
CT425 Temperature Controllers	45

Temperature Sensors



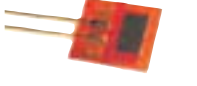

Fast response and easy installation

Minco is a leading manufacturer of temperature sensors. We have hundreds of common model configurations in stock for immediate shipment. Visit minco.com/components to see what we have in stock. Below is a selection of popular sensors for use with our heaters and controllers.

Thermal-Ribbon™ RTDs, Thermocouples and Thermistors

	Model	Material	Dimensions	Temperature
	S665PDY40A* (100 Ω) S665PFY40A* (1000 Ω) TS665TFY40A* (50k W at 25°C NTC thermistor)	Polyimide substrate with elastomer cover, 2 or 3 PTFE leads	0.2" × 0.5" (5 × 12 mm) Lead length: 40" (1000 mm)	-50 to 155°C -58 to 311°F (except TS665 to 125°C/257°F)
	PDY40A* (100 Ω) S667PFY40A* (1000 Ω) (Available with 2 leads only) Immersible	Silicone rubber substrate with elastomer cover, 2 silicone rubber leads	0.2" × 0.6" (5 × 15 mm) Lead length: 40" (1000 mm)	-50 to 155°C -58 to 311°F
	S1PDYT40A* (100 Ω) S17624PFYT40A* (1000 Ω) S17624PSYT40A* (10k Ω) Wide temperature range	Polyimide substrate and cover, 2 or 3 PTFE leads	0.2" × 0.6" (5 × 15 mm) Lead length: 40" (1000 mm)	-50 to 200°C -58 to 392°F
	S467PDY36A* (100 Ω) S468PFY36A* (1000 Ω) Flexible model designed for moist environments	Silicone rubber body, 2 or 3 rubber leads	S467: 0.5" × 1.5" (13 × 38 mm) S468: 0.5" × 3.0" (13 × 76 mm) Lead length: 36" (900 mm)	-62 to 200°C -80 to 392°F
	S651PDY24A* (100 Ω) Miniature spot sensor with wire-wound RTD element	Polyimide with foil backing, 2 or 3 PTFE leads	0.30" × 0.30" (7.6 × 7.6 mm) Lead length: 24" (600 mm)	-200 to 200°C -328 to 392°F
	TC40JT36A* (Type J) TC40KT36A* (Type K) TC40TT36A* (Type T) Patch-style thermocouple	Polyimide with PTFE leads	0.75" × 0.75" (19 × 19 mm) Lead length: 36" (900 mm)	-200 to 200°C -328 to 392°F

RTD probes and elements

	Model	Material	Dimensions	Temperature
	S614PDY12T* (100 Ω) S614PFY12T* (1000 Ω) General purpose encased sensor	Stainless steel, 2 or 3 PTFE leads	0.188" ø × 2" long 4.8 ø × 51 mm long Lead length: (300mm)	-269 to 260°C -452 to 500°F
	S853PD120Y36* (100 Ω) Tip sensitive probe	Stainless steel with copper alloy tip, 2 or 3 PTFE leads	0.250" ø × 12" long 6.4 ø × 305 mm long (other lengths available) Lead length: 36" (900mm)	-50 to 260°C -58 to 500°F
	S245PD12 (100 ± 0.12 Ω) S245PD06 (100 ± 0.06 Ω) S247PF12 (1000 ± 0.12 Ω) S247PF06 (1000 ± 0.06 Ω)	Ceramic/glass body, silver leads	S245: 0.08" × 0.09" (2 × 2.3mm) S247: 0.08" × 0.20" (2 × 5.0mm) Lead length: 0.6" (15mm)	-70 to 400°C -94 to 752°F
	S270PD12 (100 ± 0.12 Ω) S270PD06 (100 ± 0.06 Ω) High temperature, high precision element	Ceramic body, platinum leads	0.047" ø × 0.59" long (1.28 ø × 15mm long) Lead length: 0.4" (10mm)	-200 to 850°C -328 to 1562°F

Note: Except where noted, all RTDs have 100 ± 0.12% Ω platinum element, TCR = 0.00385 Ω/Ω/°C (pt100 per IEC 751 Class B). Part number codes: For Thermal-Ribbons only, change the "A" to "B" for acrylic PSA backing. Change "Y" to "Z" for 3-lead model.



Temperature Controllers

Choose the control method that works best for your application

Uncontrolled system

If powered without regulation, a heater will rise in temperature until heat losses (increasing with temperature) equal heat input. This may be acceptable in rare situations, but normally is avoided because the equilibrium temperature is highly unpredictable. In most cases the heater temperature needs to be controlled. This allows the heater to ramp up to setpoint faster without fear of overshooting and burning out the heater.

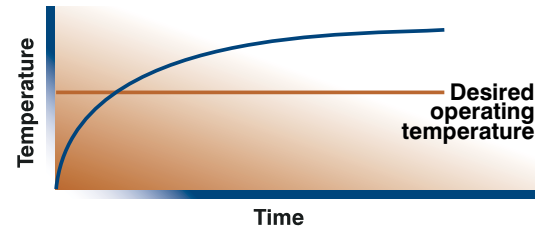

On/off control

On/off is the most basic form of control: Full power on below setpoint, power off above setpoint. Electronic on/off controllers offer faster reaction time and tighter control than thermostats. All on/off controllers have a differential (hysteresis or dead band) between the on and off points to reduce rapid cycling and prolong switch life. With on/off control, temperature never stabilizes but always oscillates around the setpoint.

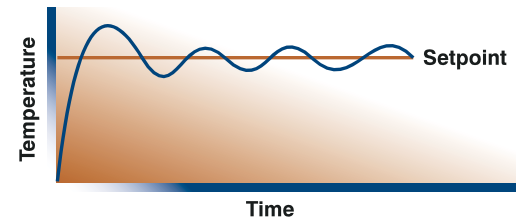

Proportional control

A proportional controller reduces power as the heater approaches setpoint. This reduces oscillation for steadier control. Note that most controllers are "time proportioning," where they scale power by rapid on/off switching. Short cycle times usually require a solid state relay for power switching. Simple proportional controllers can experience "droop" where the temperature settles at a point near the setpoint but not exactly on it.

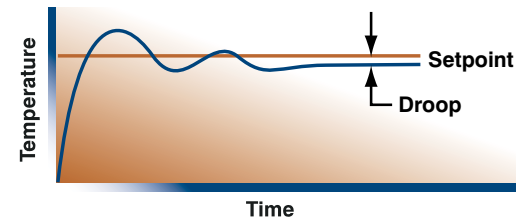

PID controllers

Proportional/Integral/Derivative controllers solve the problem of droop and otherwise improve control accuracy through advanced digital algorithms. They have various tuning parameters for best control, but typically have some preset modes suitable for most situations.

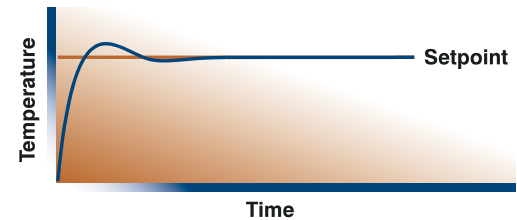

Custom Control Solutions

In high volume applications, a specially designed controller often gives the best performance and price. Controllers can be standalone devices or embedded in other electronics, allowing you to monitor and control your system automatically.

Contact Minco today and learn how we can help configure the perfect product for your application.

Choose the Right Controller

The following table illustrates the differences between the CT325 and the CT425.

Minco controller model	Control method	Supply power	Sensor input	Controlled output
CT325	On/off	4.75–60 VDC	PD: 100 Ω platinum RTD PF: 1000 Ω platinum RTD TF: 50k Ω thermistor	Same as supply power
CT425	PID, proportional, on/off (selectable)	CT425A: 120 VAC CT425B: 10.5-60 VDC CT425C: 240 VAC	PD: 100 Ω platinum RTD PF: 1000 Ω platinum RTD	Same as supply power

CT325 Miniature DC Temperature Controller

Inexpensive heater control

Overview

The CT325 Miniature DC Temperature Controller is designed for use with Minco Thermofoil™ heaters and RTD or thermistor sensors. It offers inexpensive on/off temperature control of your process or equipment with accuracy many times better than bimetal thermostats. Easily read and adjust the set point temperature using a voltmeter, then monitor the actual signal temperature at the other end. Operating from your 4.75 to 60 volt DC power supply, the controller can switch up to 4 amps power to the heater. A bright LED indicates when power is applied to the heater.

- The entire unit is epoxy filled for moisture resistance, with a through-hole for a mounting bolt. A terminal block provides the power input, sensor input and heater output connections.
- Tight control in a small package means that enclosures or panel spaces are not required which allows successful portable device implementation.
- Simple control without complicated programming can reduce set-up time.
- Three-wire RTD connection cancels lead resistance for highly accurate temperature readings.
- Solid state on-off control with adjustable set point improves durability compared to electro-mechanical devices.
- Flexible heating control compliments all Minco Thermofoil heaters for convenient off the shelf operation.
- Uses standard 100Ω or 1000Ω platinum RTD or 50kΩ thermistor sensor input.
- Single DC power source provides power to the controller and heater up to 240 watts.

Applications

- IV solutions for medical/surgical applications
- Military batteries
- Enclosures to maintain the temperature of electronics
- Ruggedized laptop LCDs and hard drives

Custom design options

Minco can customize the design of the CT325 for special applications. Specific temperature ranges, other sensor options, and special packaging are possible for volume OEM applications.



Specifications

- Input: 100Ω or 1000Ω platinum RTD, 0.00385 Ω/°C, 2 or 3-leads, or 50kΩ NTC thermistor, 2-lead.
- Setpoint range: 2 to 200°C (36 to 392°F) for platinum RTD input. 25 to 75°C (77 to 167°F) for thermistor input. Consult factory for other ranges.
- Setpoint stability: ±0.02% of span/°C.
- Vtemp signal: 0.010 V/°C over specified range.
- Deadband: ±0.1°C (0.2°F).
- Input power: 4.75 to 60 VDC.
- Output: Open drain, 4 amps max. DC.
- Leadwire compensation: (3-wire RTD) ±0.06°C/Ω for 100Ω or 1000Ω platinum up to 25 Ω per leg.
- Fault protection: Heater disabled on RTD short or thermistor open. No heater protection; external fuse is recommended.
- Operating ambient temperature range: -40 to 70°C (-40 to 158°F).
- Relative humidity: 0 to 95% non-condensing.
- Physical: Polycarbonate case, epoxy sealed for moisture resistance.
- Weight: 1 oz. (28g).
- Connections: Terminal block for wires AWG 22 to AWG 14.
- Mounting: Mounting hole for #6 screw through or #8 thread forming screw.

CT325 Miniature DC Temperature Controller

Specification options

CT325	Model number
PD	Sensor type from table below
1	Power supply: 1 = 4.75 to 10 VDC 2 = 7.5 to 60 VDC
C	Temperature range: A = 25 to 75°C (thermistor only) C = 2 to 200°C (RTD only)
1	Dead band: 1 = 0.1°C
CT325PD1C1 = Sample part number	

Sensor type	Code
100 Ω platinum RTD	PD
1000 Ω platinum RTD	PF
50k Ω thermistor	TF

Specification options

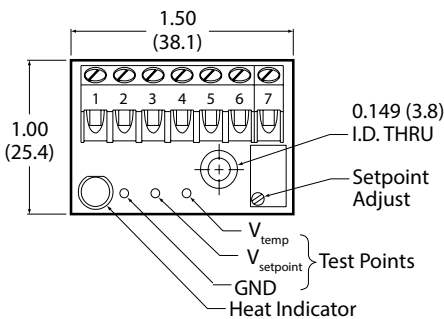

Note: Sensors often used with the CT325 are found at the beginning of this section.

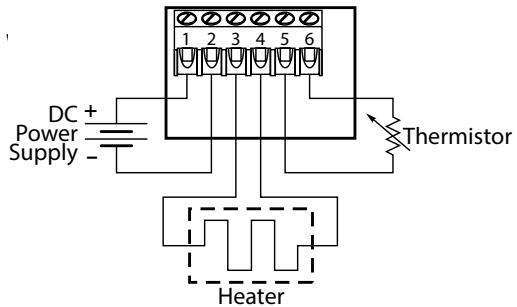
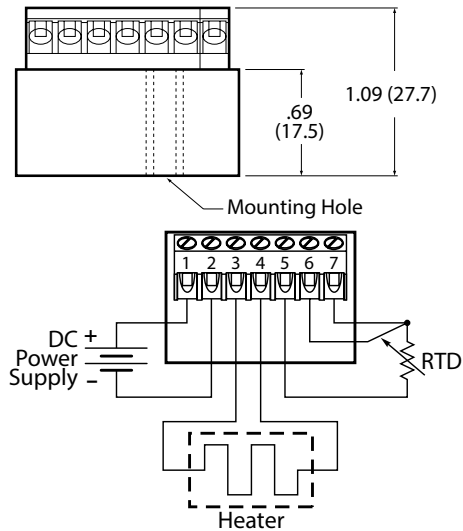

AC powered heaters

The CT325 can provide the control signal to an external solid state relay to switch AC power. Use 15 VDC as the control voltage.

CT425 Temperature Controllers

Versatile, configurable controller

Overview

Minco's CT425 Temperature Controller is a PID temperature controller capable of reading two independent temperature sensors (RTDs). By utilizing an internal solid state relay, logic voltage output, and internal mechanical relay, the controller is fully configurable. Simply connect the CT425 to a laptop or PC to configure.

Features

- Flexible configuration for:
 - Inputs
 - Utilize one or two Platinum RTDs
 - Choose 100 or 1000 ohm RTDs

Outputs

- Utilize up to three outputs
 - Solid state relay
 - Logic voltage
 - Mechanical relay
 - Choose control type
 - PID
 - On/Off (mechanical relay only)
 - Alarm
- USB and a user-friendly software package allow for easy setup and use
- 32-bit microprocessor executes both PID loops simultaneously at individually configurable rates up to 25 times/second
- High current capacity internal switching
- Electrically isolated switching outputs increase high voltage safety
- AC powered models perform zero-cross detection to reduce switching noise
- LED indicators provide a quick confirmation of correct sensors input operation



Programming

All configurations are performed through the Windows application. The CT425 may be powered through USB if desired. This allows the user to configure the unit, or simply become familiar without having to connect separate power.

Applications

The CT425 is designed for a variety of applications that include heating and cooling of equipment or processes. The CT425's versatility makes it ideal to use as an off-the-shelf prototyping tool or as an economical controller for small to medium volume applications. Moreover, the CT425's modular design provides the platform for fast and cost-effective custom designs for medium to high volume applications.

Bluetooth Low Energy

A Class 2 Bluetooth Low Energy (BLE) modem has been included on the CT425 to allow wirelessly viewing of temperatures and changing of set points using an Android or Apple smartphone. The primary purpose of this is to monitor real-time operation of the CT425 without using a PC because the CT425 does not have a display.

Datalogging

The on-board data-logger is active as long as the CT425 is powered. It does not affect any other function and therefore, is completely transparent to the user. The logger uses the circular buffer concept which means that once the entire available memory is filled with samples, the oldest data is overwritten with new data. This will store a number of the most recent samples, with the older samples overwritten with newer data.

Stock CT425 Temperature Controllers

Buy on Minco.com

The CT425 is a universal temperature controller that supports two platinum RTD inputs and three outputs. Thermistors are also supported to a limited extent. A 32 bit processor allows up to two PID loops to operate simultaneously at individually configurable loop rates up to 25Hz. An autotune feature generates PID coefficients, and all configurations are performed through a Windows application over a USB connection.



Model #	Installation method	Compatible Sensors	Operating temp	Dimensions	# Inputs	# Outputs	Power
CT425A	Flange mount	100 and 1000 Pt	-25°C to 55°C	3.35" x 5.50" x 1.25"	1-2	3	120 VAC
CT425B			-25°C to 55°C	3.35" x 5.50" x 1.25"	1-2	3	10.5-60 VDC
CT425C			-25°C to 55°C	3.35" x 5.50" x 1.25"	1-2	3	240 VAC

Reference

FAQ	48
Glossary	51
Industry Specifications for Heaters	54

Frequently Asked Questions

Refer to these FAQs to learn more about Minco's heater offerings

Thermofoil Heaters

What is the correct voltage for this heater?

Standard heaters are specified by resistance, not voltage. This lets you operate them at different power levels. In selecting a heater model you should consider the size, resistance, operating temperature, total wattage and watt density (watts/in² or watts/cm²) for your application. The watt density rather than the total wattage determines the maximum applied voltage. Maximum watt density depends on the insulation type, mounting method and operating temperature. Graphs of these limits are included in each product section of this bulletin.

Minco standard and stock wire-wound silicone rubber heaters are listed with a recommended voltage based on typical ambient conditions and operation. It is often possible to exceed the listed limits. Contact Minco for more information if your application requires more power than the standard limits allow.

Can a Thermofoil heater be used suspended in air?

Because the mass of a Thermofoil heater is very small they are generally not suitable for heating in air. Thermofoil heaters operate best when mounted to an object that can be heated by conduction rather than convection or radiation.

What are the dimensions of the lead attachment area for standard heaters?

The size of the non-heated lead attachment area varies based on the leadwire size, insulation material, lead exit location and heater dimensions. For a polyimide (e.g. Kapton™) insulated heater these range from 0.25 x 0.30" (6.35 x 7.62mm) to 0.5 x 0.8" (12.7 x 20.32mm) for sizes AWG 30 to AWG 20. Describe your space limitations when specifying a custom design. Leads can be attached to a non-heated tab outside the body of the heater.

What is the temperature coefficient of resistance (TCR) for Minco heater elements?

Standard etched element heaters (except resistance options listed under the "NiFe" and "Ni" columns) use very low TCR foil materials. These can be considered to have a flat resistance to temperature relation for most applications.

Etched element heaters under the "NiFe" and "Ni" columns use either nickel (0.00672 Ω/Ω/°C) or nickel-iron (0.00519 Ω/Ω/°C) foil. Thermal-Clear heaters use copper wire (0.00427 Ω/Ω/°C), nickel wire (0.00672 Ω/Ω/°C), or nickel-iron wire (0.00519

Ω/Ω/°C). These higher TCR models are not self-limiting but can be used with Minco's Heaterstat controller where the heater element performs the sensor function.

Can I immerse these heaters in water or other liquids?

Generally the answer is no. The materials used in Polyimide insulated Thermofoil heaters are waterproof, but edges are not sufficiently sealed for immersion. Custom designs (including all PTFE heaters) can include increased border areas and sealed leadwire connections that make these heaters immersible in water. Silicone rubber insulated heaters require RTV cement or similar materials along all exposed edges and leadwire attachment areas for immersion in water.

If your application requires contact with other liquids contact Access: Minco Sales and Support with details and we can help design a solution.

Can I trim a Thermofoil heater to the size and shape I need after I've received it?

No- Thermofoil heaters cannot be cut or trimmed. The element conductor covers the entire area to maximize the heat spreading effect of the etched-foil design. Cutting into this would create an electrically open circuit and expose the electrically live element.

When would I specify aluminum foil backing for a heater?

Foil helps to spread heat between heater strands, improves adhesion of PSA, and makes polyimide less springy for better conformance to curves. It increases the temperature and watt density ratings of polyimide heaters with PSA. For silicone rubber heaters, foil with acrylic PSA is less expensive than #12 PSA applied directly to the rubber.

SmartHeat SLT Heaters

Is SmartHeat SLT most similar to a resistor, capacitor, or inductor?

SmartHeat is a resistive technology. What separates this product from traditional resistive technologies is a unique positive temperature coefficient (PTC), which establishes a strong, exponential relationship between resistance and temperature. This creates a self-tuning effect that makes SmartHeat suitable for a variety of warming applications.

SmartHeat utilizes a resistive foil bus-pattern to deliver a voltage potential to the underlying heating foil. This bus-pattern may act as an inductor in certain configurations, but this is a byproduct of the design and not the intended function.

How does SmartHeat respond to drastic changes in environmental conditions?

SmartHeat strives to maintain a constant temperature. It will produce high power when attached to a cold object, and will rapidly warm the object to its set point while never exceeding a prescribed safety temperature. As the heatsink and environment change, the heater will increase or decrease its power output to compensate.

I understand that SmartHeat is inherently self-controlling, but is there any advantage to using a secondary, external controller with SmartHeat?

It may seem counterintuitive to add a feedback loop to a “controller-free” system, however there are situations where this is a very reasonable approach. For instance, critical applications may require two independent thermal shutoffs. While SmartHeat can suffice for the first level of safety, an additional thermal fuse or thermostat may be required as a secondary level.

Other applications may require a combination of precise set point control and built-in safety. The addition of an external sensor allows the system to be tuned to a more precise set point (especially in highly dynamic environments), while the core SmartHeat layer gives the system a built-in safety mechanism.

Is it possible for SmartHeat to act as an On/Off controller that is only active below a specified temperature?

SmartHeat will gradually reduce its power output above the designed set point for the system. It does not have the same complete cut-off characteristic as an On/Off controller. Instead, SmartHeat should be thought of as a no-overshoot PID controlled system. SmartHeat will only draw as much power as is needed to maintain its equilibrium set point. In a warm, low-load environment, the heater will draw significantly less power than in a cold, high-load environment. It will react to changes in load by increasing or decreasing its power output to maintain equilibrium.

Is the SmartHeat construction UL rated?

Minco’s SmartHeat construction is not yet UL rated. The outer encapsulant (polyimide) is UL recognized, however the core heating layer has not been tested. This testing is on the roadmap for the product line and the results will be made available as soon as they are ready.

What are the storage requirements for SmartHeat technology? If heaters are stored for years, will they be operational when they are put into service?

SmartHeat should be stored in a clean, dry environment with temperatures between -40°C to 100°C and humidity up to 95%, non-condensing. In these conditions a SmartHeat device can be expected to remain indefinitely prior to placement into service.

What is the durability of SmartHeat? How long of a lifecycle can be expected?

Minco is currently collecting lifecycle data for SmartHeat. As of the writing of this FAQ, various SmartHeat constructions have been under power in a test environment for nearly 2 years with no measurable degradation to heater performance. Minco does not anticipate any issues using SmartHeat for critical, long-term applications in excess of 10+ years and will continue collecting data to confirm. It is however at the discretion of the customer to validate SmartHeat for their end use application and required longevity.

Is the SmartHeat construction durable enough to withstand repeated bending?

Yes, SmartHeat is constructed from durable, flexible materials that can withstand static or dynamic bending. It is important that areas with dynamic bending be discussed early on, as this can affect the positioning and layout of the termination area.

Can SmartHeat withstand pressure application from lamination, clamping, or natural weight of the heatsink?

SmartHeat is capable of withstanding high, uniform pressure. It is important that the pressure be well distributed across the heater’s surface to prevent puncture or physical damage. Pressure lamination, mechanical clamping, and the weight of common heatsinks are readily managed by SmartHeat.

What is the typical thickness of a SmartHeat device?

Minco’s standard SmartHeat construction measures 0.013 inches nominal. The minimum available thickness on a custom basis is 0.011 inches nominal. Heaters that require pressure-sensitive adhesive backing, a metallic heat spreader, insulating foam, or high dielectric strength will have increased thickness and should be quoted by Minco engineering.



What are the size limitations for your SmartHeat product line (i.e. the biggest and smallest heater you can produce)?

The maximum size heating element that Minco is capable of manufacturing is 7 in. x 22 in. Larger heaters can be manufactured by combining (stitching) multiple heating elements on a common polyimide substrate and cover. The maximum size stitched heater Minco is capable of manufacturing is 22 in. x 42 in.

The minimum size heating element that Minco is capable of manufacturing is 0.5 in. x 1 in. Smaller heaters can be manufactured by locating the termination area on an external tab, or by using surface mount or pin-header connections.

Does SmartHeat take any longer to design or build than a traditional etched-foil heater?

No, SmartHeat is built with the same methods and equipment as a traditional etched-foil heater. Leadtimes between traditional products and SmartHeat products are comparable. In cases where the thermal load is significant or highly dynamic, multiple prototype iterations may be required to achieve the designed set point for the system. This is a normal part of the design process that can be discussed up front with Minco Engineering.

What is the maximum power density that can be achieved with SmartHeat?

SmartHeat strives to maintain a constant temperature and will produce as much power as is necessary to maintain equilibrium. Each heater will adjust its resistance, and in turn wattage based on the heatsink, contact method, and environment temperature. Minco designs heaters for a constant temperature. It is then up to the surroundings to determine what the wattage and warm up time will be when the heater is turned on.

The maximum power density is both application and design specific. For new applications, it is recommended that customers work with catalog/standard heaters for proof of concept testing. This is the most reliable means to characterize SmartHeat's power density for a specific application.

What is the maximum current draw that should be expected from SmartHeat during a cold start? Is there any way to limit or reduce the startup current?

Start current, similar to power density, is application and design dependent. As a rough approximation, the start current can range from 5x to 20x the steady state current. The exact value is dependent on various parameters including the design formulation, supply voltage, heater size, coverage, insulation, and environment temperature on startup.

In cases where design strategies do not fully address startup-current concerns, there are simple electrical components that can be added to the heater design. Both fixed inductors and negative temperature coefficient (NTC) thermistors can offer a cost effective way to lower the startup-current while still not adding the cost, weight, and complexity of an external control system. The addition of the thermistor significantly reduces the peak startup-current, but does slightly increase the time required to get to steady state.

What is the difference between set point temperature, element temperature, and safety temperature?

Set point temperature is measured at the heatsink. It is the desired temperature that the heatsink should be warmed to. This value is generally customer driven and varies based on the application and condition of the heatsink at equilibrium.

Element temperature is measured at the internal heating element. This value is Minco driven and depends on the connection method, environmental conditions, heatsink type, and relative size of the heater to the heatsink. The element temperature will always be higher than the set point temperature due to thermal losses between the heating element and the heatsink.

Safety temperature is the upper shutoff point for a SmartHeat device. Above this temperature, the heater will produce minimal power. This built in shutoff point is integrally tied to the set point and element temperatures. SmartHeat devices are designed to prevent thermal runaways and to protect surrounding materials that are prone to thermal damage.

What temperature set points are available for SmartHeat? Is the set point adjustable in the field?

Minco is capable of designing SmartHeat for temperature set point between 10°C and 70°C. Please consult your local sales representative for applications outside of this range, or for applications with high thermal loading (subzero climates or dense metallic heatsinks).

Set point is established during manufacturing and cannot be adjusted in the field, except through the use of a variable voltage power supply.

Glossary

Minco's heater terminology defined

All-in-one Heater: A heater which incorporates the functions of an external sensor and controllers.

Anti-reset windup: Turns off integral action outside the proportional band to prevent false accumulation of error during warmup.

AP (All-Polyimide): Flexible heaters with adhesiveless substrate and covers. High temperature capabilities to 260°C.

AWG (American Wire Gauge): An indicator of wire diameter. The larger the number, the smaller the diameter.

Carbon-Silicone Matrix (CSM): SmartHeat's silicone layer, embedded with carbon particles.

Conduction: The transfer of thermal energy between adjacent bodies (usually solids) or parts of the same body.

Convection: The transfer of thermal energy in fluids and gases by mixing warmer areas with cooler ones. Convection currents can form, due to differences in density. Generally, warmer fluids (or gases) are less dense and tend to rise.

Coverage: Heater coverage is the percentage of the available area within a heater that is covered with heater element strands. Most of Minco's heaters are designed with 50% coverage but reduced or increased coverage can offer advantages in some designs.

Creep action: A switching method, often used in thermostats, in which a temperature-sensitive bi-metallic element causes slow make and break of electrical connections. In contrast to snap action, this method results in tighter temperature control, but greater electrical noise and usually shorter life.

Cycle time: The duration of an on/off cycle with time proportioning. With cycle time of 10 seconds, for example, 80% power would give 8 seconds on, 2 seconds off. General rule: Shorter times give better control and less oscillation, but require solid state relay.

Damage-Tolerant: The characteristic of SmartHeat that allows it to continue functioning after sustaining breaks in one or more layers of the heater.

Deadband: The temperature difference between full "on" (when temperature is falling), and full "off" (when temperature is rising), for an on/off controller. The deadband is intentionally designed to reduce oscillation.

Derivative: Adjustment to output based on the process's rate of change, usually to allow faster recovery from upsets. Also expressed as "rate." General rule: Increase derivative time if system frequently overshoots; decrease if system acts sluggish.

Dielectric strength: The maximum voltage (typically AC) that an insulation material can withstand before material break down occurs.

Droop: An error inherent in simple proportional control where the temperature reaches equilibrium at a point other than setpoint, but still within the proportional band.

Dual-element Heater: A Thermofoil Heater that contains two heating elements within the same unit.

Etched-foil: A method of producing pre-determined electrical paths, by chemically removing (etching) the areas which will not carry electric current. This process can be used to manufacture heaters, flex-circuits, and temperature sensors.

FEA (Finite Element Analysis): A numerical method used to predict the behavior of a heater/heat sink design. It is typically employed only if actual modeling is not practical.

FEP (Fluorinated Ethylene Propylene): A thermoplastic adhesive in the PTFE family of polymers.

Flex circuit: A printed circuit made with flexible materials for compact electrical interconnects.

Heat sink: The body to which a heater is affixed.

Heat transfer: The transfer of thermal energy between bodies of different temperature.

Heater Backing: A material applied to one or both sides of a heater. A sheet adhesive, such as a PSA, can be used to affix a heater to an object that must be heated. A foil layer bonded to the surface can serve a variety of purposes. But most often, it serves as a lateral heat spreader.

Heaterstat: A Minco temperature controller that uses the heating element as a temperature feedback sensor.

Hysteresis: The temperature difference between full "on" (when temperature is falling), and full "off" (when temperature is rising), for an on/off controller.

Insulation resistance: The actual resistance of an electrically insulating material. Measuring devices typically use high DC voltage to perform the measurement.



Integral: A controller feature that continuously compensates for droop by integrating errors over time and adjusting the proportional band up and down. Also expressed as “reset” (integral time = 1/reset rate). General rule: Short integral times give faster correction, but too short causes oscillation.

ISO 9001: A quality management system that is accepted worldwide.

Kapton™: An amber-colored, polyimide material that has high temperature capability and very good mechanical, chemical, and electrical insulating properties. Kapton is a DuPont trade name.

Laminate: To bond materials using heat and pressure.

Mica: A fairly brittle phyllosilicate mineral used to insulate heaters. It is used primarily for its high temperature and high watt density capabilities.

On/off: A simple control scheme where output is on below the setpoint, off above, as with a thermostat.

Outgassing: The expulsion of gases, especially in a vacuum or high temperature environment.

Overtemping: A heater exceeding its target temperature due to damage or to the heater itself or one of its external components

PID (Proportional, Integral, Derivative): A control algorithm incorporating proportional, integral, and derivative action.

Polyester: A synthetic polymer used to electrically insulate heaters, flex-circuits, and Thermal-Ribbons™. It is an economic alternative to polyimide, when high temperature and chemical resistance are not critical.

Polyimide (Kapton): A flexible, amber-colored, translucent film to electrically insulate heaters, flex circuits, and Thermal-Ribbon sensors. It is widely used for its temperature range and resistance to chemicals. DuPont’s tradename for Polyimide is Kapton™.

Point-wise Thermal Regulation: The ability of SmartHeat to control heating at individual points on the heater surface based on ambient conditions at each point.

Prescribed set point: The temperature goal designed into a SmartHeat heater as the point of production.

Profile: A method of providing uniform temperature, by varying watt density in a single heater to accommodate non-uniform heat loss from the heat sink.

Proportional band: A region around the setpoint where the output is proportional to the process’s distance from that setpoint. For example, 100% heater power during warmup is proportioned to 75%, then 50%, then 25% as temperature nears setpoint. General rule: Set just wide enough to prevent temperature from wandering outside band during normal operation.

Proportional control: A control method where the controller output is proportional to the temperature difference from set point.

PSA (Pressure-Sensitive Adhesive): An adhesive that does not require heat or extreme pressure to apply. Simply peel off the release liner, and firmly press into place.

PTFE (polytetrafluoroethylene): A flexible electrically insulating material known for its “non-stick” characteristic. It is often used for its excellent chemical resistance. DuPont’s tradename for PTFE is Teflon™.

Quantum Tunneling: The process by which electrons travel between conductive carbon particles in a non-conductive silicone matrix.

Radiation: The transfer of thermal energy through space (especially a vacuum) by electromagnetic waves.

Resistance density: Resistance per unit area. Usually listed as a maximum, it is dependent upon construction materials such as foil, adhesive, and insulation.

Resistance tolerance: The range of actual resistance from nominal (or target resistance), at a reference temperature (usually 0°C). Generally, wire elements have a tighter resistance tolerance than etched foil elements.

RS-485: A communication standard for interfacing computers to process instruments. Allows multiple instruments on a single twisted-pair cable. Convertible to RS-232 with proper adapter.

RTD (Resistance Temperature Detector): A sensor whose resistance changes with temperature. The most accurate of commonly used thermometer types.

Safety Temperature: The temperature at which a SmartHeat heater becomes an isolator, completing shutting down current flow.

Self-limiting technology (SLT): The characteristic of the carbon-silicone matrix (CSM) that stops current flow at any area where the set-point temperature is reached.

Set point: The temperature at which a controller is set to control a system. In SmartHeat SLT heaters, the setpoint is the temperature at which the heater is designed to reach and maintain.

Shrink band: Pre-stretched strips, that shrink when heat is applied, for mounting heaters or temperature sensors to cylinders.

Silicone rubber: A flexible, synthetic elastomer used to electrically insulate heaters and Thermal-Ribbons™.

SMT (Surface Mount Technology): A printed circuit wiring method that uses solder pads on the surface of the circuit to mount components, thereby eliminating through-holes.

Snap action: A switching method, often used in thermostats, in which a temperature-sensitive bi-metallic element causes fast make and break of electrical connections. In contrast to creep action, this method results in less electrical noise, but requires a significant differential between temperatures that open and close the connection, resulting in looser control.

Specific heat: The amount of heat per unit mass required to raise the temperature of a material 1°C.

SSR (Solid State Relay): A type of relay with no moving contacts to wear out, offering life many times that of mechanical relays. Best for time proportioning.

Standard heaters: Predesigned heaters that are made-to-order. Typical lead time on Minco standard heaters is 3 weeks ARO.

Stretch tape: An elastic, silicone rubber tape for mounting heaters or temperature sensors to cylinders.

TCR (Temperature Coefficient of Resistance): The average resistance change per unit resistance between 0°C and 100°C. Sometimes it is simplified to the ratio of resistance at 100°C to the resistance at 0°C.

Thermal Calc: A Minco web-based program to assist in calculating heater wattage requirements from known parameters. Thermal Calc is available at www.minco.com.

Thermal-Clear: A heater made with transparent insulation and a fine wire element. Thermal-Clear heaters transmit over 80% of visible light.

Thermal conductivity: A measure of how fast heat travels through a material. Often referred to as the “k” value.

Thermal-Ribbon sensors: Minco’s family of flexible temperature sensors, featuring a wide variety of resistance,

TCR, and temperature ranges. Thermal-Ribbon sensors can be integrated into a heater, or custom designed to virtually any shape.

Thermistor: A temperature sensor made from semiconductive material. Thermistors are highly sensitive (resistance changes dramatically with temperature), but non-linear and typically not very accurate.

Thermocouple: A temperature sensor made by joining two dissimilar metals at discrete points called junctions. Thermocouples produce a small voltage when there is a difference in temperature between junctions.

Thermofoil: An innovative heating technology from Minco, which utilizes an etched-foil process to create a flat, flexible heater for optimum heat transfer. Heaters can be designed in virtually any shape, and Minco can integrate temperature sensors, flex circuits, and control electronics.

Thermostat: A temperature-sensitive switch used as an economical on/off controller, or for overtemperature protection. See “snap action” and “creep action.”

Thin-film: An electrical component made by depositing a thin layer of metal on a substrate (usually ceramic). Thin film techniques can be used to make heaters or temperature sensors.

Time proportioning: Scaling of output by varying the ratio of on-time to off-time; i.e. 80% power = 80% full on, 20% off.

TÜV: A testing and certification organization, through which Minco has ISO 9100 accreditation, and other approvals.

UL (Underwriters Laboratories): An independent product safety testing and certification organization, recognized mostly in the United States and Canada.

ULA: A thermosetting, acrylic adhesive that is UL recognized.

Vulcanize: A process, using heat and pressure, used to bond uncured rubber to rubber, metal, ceramic, glass, etc.

WA: A thermosetting acrylic adhesive.

Watt: The heat produced by one ampere of current through a resistive load of one ohm.

Watt density: The amount of power per unit area, often expressed as watts per square inch or watts per square centimeter.



Industry Specifications for Heaters

Minco has been certified compliant with a number of international standards

Core Certifications

Minco's Quality Management System complies with a variety of market-specific standards. Minco's experience in each of our market areas enables us to understand their unique quality requirements and what it takes to meet them. We work closely with national and international standards bureaus to develop manufacturing and quality assurance procedures

Our Quality Management System has been audited and certified compliant with these internationally recognized standards. In addition, individual products also possess a variety of product-level certifications and accreditations.

To view all certifications that Minco carries, please visit our list on Minco.com.

Minco's core quality certifications are noted below:

AS9100/EN9100: 2016

ISO 9001:2015

Nadcap: Electronics AC7119 and AC7119/2

UL: Underwriters Laboratories

United States: UL 499; Standard for Safety for Electric Heating Appliances UL file number: E89693



Custom designed or standard model heaters with polyimide, all-polyimide, mica, or silicone rubber insulation may be marked as recognized components.

Canada: Specification C22.2, 72-M1984 UL file number: E89693

Custom designed or specially modified standard model heaters with polyimide, mica, all-polyimide or silicone rubber insulation may be marked as recognized components.



United States and Canada: Specification C22.2, 72-M1984 UL file number: E89693

Custom designed or specially modified standard model heaters with polyimide, mica, all-polyimide or silicone rubber insulation may be marked as recognized components.



TÜV

Specification EN60335-1: Standards for Safety of Household and Similar Electrical Appliances, Part 1: General Requirements



Custom-designed heaters with polyimide or silicone rubber insulation may be marked as recognized components.

NASA: National Aeronautics and Space Administration of the United States

Specification S-311-P-079: Procurement Specification for Thermofoil Heaters



Specification S-311-P-841: Thermofoil Heaters, All-Polyimide, and Space Applications

Minco has worked closely with NASA developing precise, reliable thermal components since the Mercury program in the 1960s. Hundreds of custom designed Thermofoil™ heaters have been built, tested and supplied for NASA projects.

European Space Agency (ESA)

Qualification Certificate 325A (France) Specification 4009/003 as recommended by the Space Components Steering Board.



Minco SAS, Aston, France has been qualified by ESA for supply of Resistors, Heaters, Flexible Single and Double Layer for use in ESA space programmes.

Telcordia Technologies (Bellcore)



Specification GR-1221-CORE: General Reliability Assurance Requirements for Passive Optical Components

Polyimide and rubber insulated Thermofoil™ heaters have been tested to these requirements of the telecommunications industry. Standard and custom designs, heater/sensors, and heater assemblies meet the requirements of this specification.

Additional Certifications

Minco may employ standards-compliant manufacturing schemes besides those listed above. For instance, we have the option to manufacture a part in compliance with REACH and RoHS. Contact Minco for additional information.

