

THE MEASUREMENT SOLUTION.

**burster**

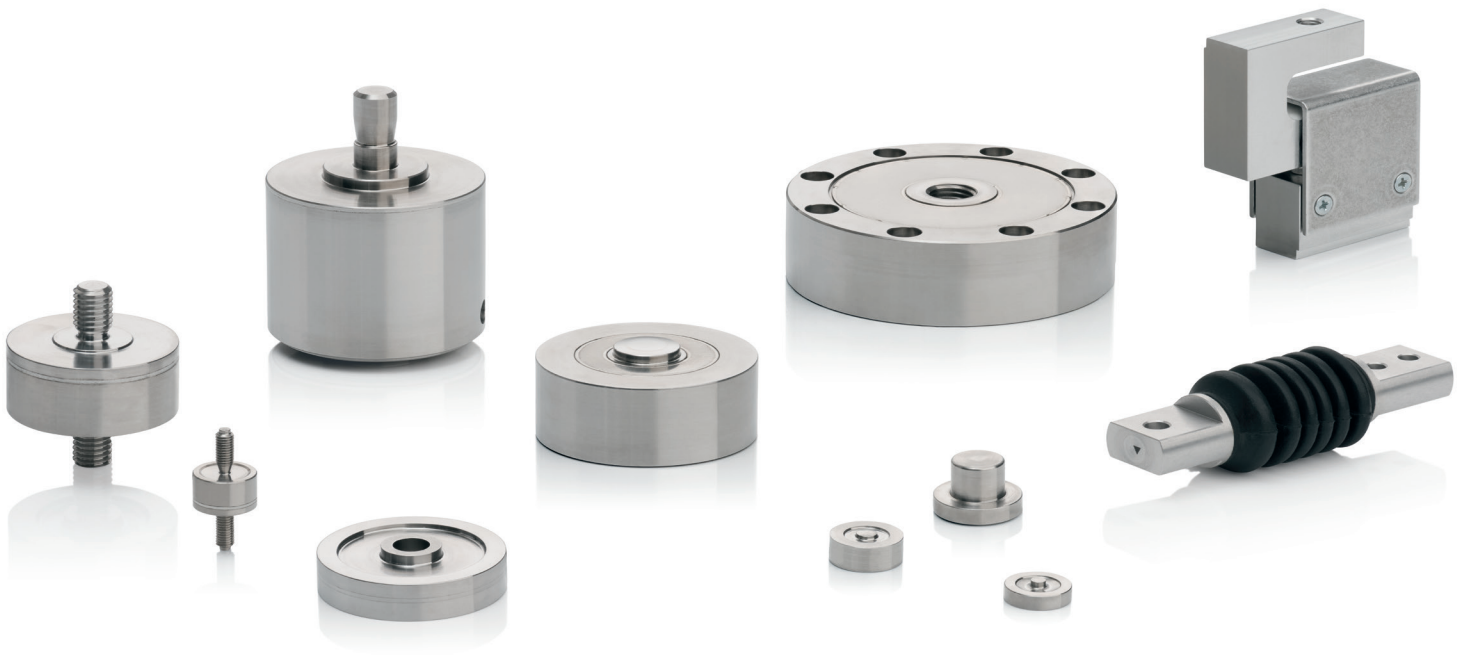

# Load cells

**FOR PRODUCTION, AUTOMATION, R&D  
AND QUALITY ASSURANCE**

[www.burster.com](http://www.burster.com)

# A powerful force taking measurements forward

**SMART LOAD CELLS KEEPING PACE WITH ADVANCES IN PROCESS CONTROL.**

## PRODUCTS DESIGNED FOR THE CHALLENGES OF OUR AGE

Our customers operate in practically every branch of industry around the world and expect products to work perfectly 100% of the time. As the requirements set by exacting production processes and quality assurance standards become ever more stringent, process control depends increasingly on sensors and analysis equipment.

**As one of the leading manufacturers of load cells,** we can provide innovative ideas, experience-led advice and smart solutions for all production and quality assurance processes. Our customers value our extensive applications experience and our high-quality, practical solutions to the demands of the market.



## VARIABLE CHALLENGES NEED VERSATILE SOLUTIONS

In addition to innovative and trusted standard products, from miniature to large-scale, here in the high-powered, high-tech Karlsruhe region of Germany we also develop and manufacture tailor-made OEM sensor solutions for very specific measurement tasks and specialized applications.

It is essential to look at the process chain in depth to find the right load cell for the job and the environment. Along with the ideal load cell, a measurement system requires mechanical parts plus instrumentation for measurement data acquisition, analysis and reporting.

burster offers high-quality load calibration equipment plus extensive testing and calibration experience to guarantee the traceability and optimum reliability you need. Analysis software and a comprehensive suite of customer services complete the burster package of solutions.

## RELIABILITY AT YOUR FINGERTIPS – burster PLUG & PLAY

Smart interaction is the key to success in a world where sharing information is ever more important. Interconnecting people, machinery and products in fully or semi-automated production processes is a challenging and demanding reality. Engineers must design processes to be easy to monitor, quantify, reproduce and analyze while aiming for ever greater reliability.

Sensor-specific data is stored in the sensor connector using innovative burster TEDS technology. The analysis instrument reads this sensor data and uses it for the automatic configuration of the evaluation electronics. This not only protects against setting incorrect parameters but makes it easier to change sensors while saving time and money spent on configuration.

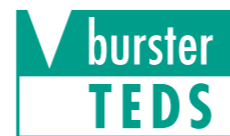

# Strength in practice

**burster LOAD CELLS FIT YOUR NEEDS PRECISELY.**

## FROM THE SPECIFIC TO THE UNIVERSAL – GLOBAL SOLUTIONS

Force measurement is increasingly relevant to growth markets such as the automotive engineering, electro-mobility, drive technology and machine manufacturers. burster has decades of experience in designing, building and using standard and custom OEM load cells and in providing valuable applications advice in many different industrial and research sectors, making burster expert in solving the optimum force measurement solution. **Take advantage of our experience now to gain that competitive edge.**

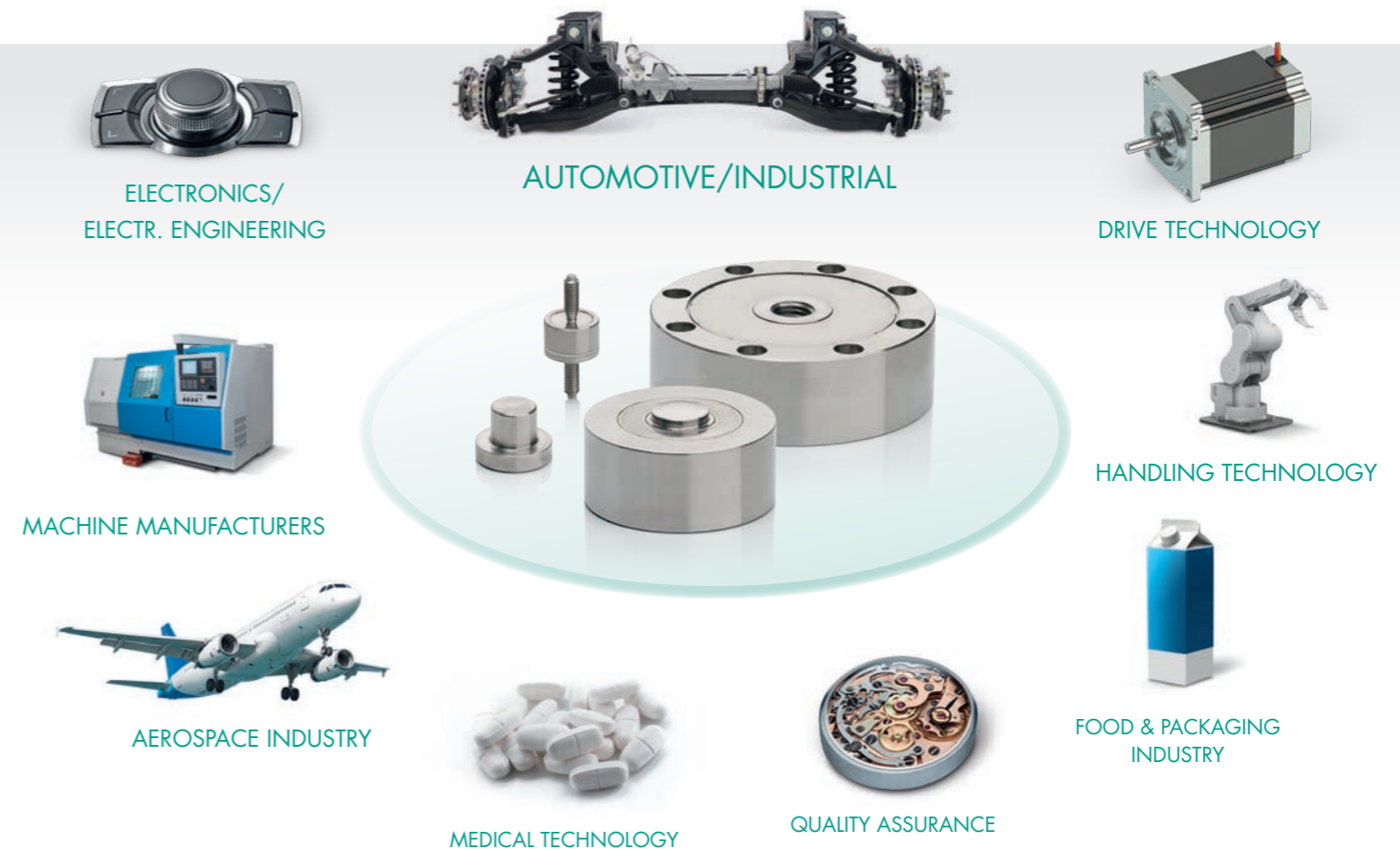

## SPARTAN OR SOPHISTICATED – EXPERTLY DESIGNED STANDARD AND CUSTOM OEM PRODUCTS

As a load-cell manufacturer with decades of design and production experience gained within the same company, burster is able to offer economically viable custom OEM solutions even for highly specialized applications, modified standard sensors or strain gage attachment to original customer parts. Our skills portfolio ranges from solving simple force measurement tasks to designing complex force monitoring systems.

For instance outstanding, future-proof measurement solutions can be achieved by combining a load cell with the DIGIFORCE® process controller range or the new fieldbus-compatible 9250/9251 instrumentation amp technology. This lets you log and visualize your processes reliably while transferring the OK/NOK analysis results to your control environment via the latest Ethernet-based fieldbuses. In other words Industry 4.0 right here, right now.

**Standard product, custom solution or an exclusive OEM product?  
Low-cost or high-end? Which route do you want to take with us?**

# Force measurement done properly

**burster – PERFECTLY SKILLED IN THE ART OF LOAD CELL DESIGN.**

## LOAD CELLS – THE WAY TO MEASURE THE MECHANICAL VECTOR QUANTITY OF FORCE (F)

Load cells consist of a spring element, which experiences elastic and linear deformation as a result of the force being measured, and a device for measuring this deformation. There are various ways of measuring small deformations. The aim is always to map the mechanical parameter “deformation” onto the electrical parameter “voltage”.

### Diversity – The different sensor elements and their most common designs. How to make the right choice for your application.

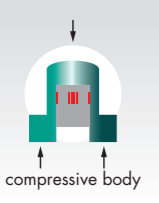
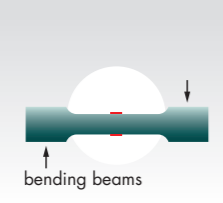
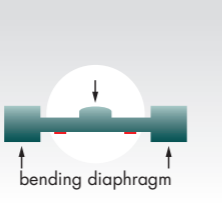
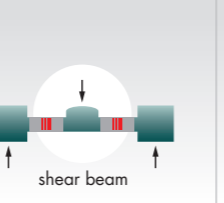
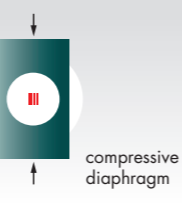
				
<ul style="list-style-type: none"> <li>Smallest possible design</li> <li>Less sensitive to impact loads</li> <li>Covers large measuring ranges</li> </ul>	<ul style="list-style-type: none"> <li>High precision</li> <li>Large nominal displacement</li> <li>Good-value external overload protection</li> </ul>	<ul style="list-style-type: none"> <li>Low-cost design</li> <li>Low overall height</li> <li>Small diameter possible</li> </ul>	<ul style="list-style-type: none"> <li>Frequent load cycles</li> <li>Insensitive to lateral forces</li> <li>Suitable for dynamic loads</li> </ul>	<ul style="list-style-type: none"> <li>High rigidity</li> <li>Withstands external forces</li> <li>Suitable for impact loads</li> </ul>

### SPRING ELEMENT – the central component

The purpose of the spring element is to absorb the force to be measured and convert it into a uniform strain range. The elastic properties of the spring materials are used to measure the force indirectly. Strain gages measure the strain on the surface of the spring element. Strain gages are made of a metal foil rolled onto a substrate. A meandering resistive pattern is etched from this metal foil.

### STRAIN GAGES – transform force into signal

Complicated processes are used to apply strain gages to the surface of the spring element. At burster this is obviously done with the greatest precision and maximum quality, to ensure they are subject to the same deformation as the spring element. When the strain gages are deformed, they change their length and conductor cross-section. The effect of both is to increase the electrical resistance. This expansion or compression, and hence the force, is measured electrically as a change in resistance.

### LOAD CELLS – accurate in every situation

Load cells have to cope with a huge range of mechanical conditions. For instance they may have to fit into tight spaces, deliver exceptionally fast readings, withstand lateral forces, deal with impact loads or track frequent load changes. This is why differently shaped measuring elements are used in the sensors, each possessing specific advantages for their area of use.

### PRECISION – everything in its place

The design of every measuring element is concerned with providing on the sensor a suitable location on which the strain gages can be applied. This location must provide enough space to accommodate the strain gages so that they produce a strain as specified and exhibit absolutely linear and reproducible behaviour.

# Your guide to precision force measurement

**SENSORS AND SERVICE FOR EVERY APPLICATION.**

## CONTENTS

<b>Measuring force</b> in the industrial environment	2
<b>Applications</b> of force measurement using standard and OEM solutions	3
<b>Useful background knowledge</b> on force measurement and sensor designs	4

## SENSORS/APPLICATIONS

### COMPRESSION LOAD CELLS

<b>8402</b>	Miniature	6
<b>8413/8414</b>	Subminiature	8
<b>8526</b>	Compact	10
<b>8415/8416</b>	Miniature	12
<b>8438</b>	Miniature	12
<b>8532</b>	Low-cost	14
<b>85043/85073</b>	Precision	14
<b>8527</b>	High-precision	16
<b>8451/8552</b>	Load cells for presses	16

### TENSION & COMPRESSION LOAD CELLS

<b>8524</b>	Precision – internal thread	18
<b>8435</b>	Miniature – internal thread	20
<b>8523</b>	Standard – internal thread	22
<b>85041/85075</b>	Precision – internal thread	22
<b>8431/8432</b>	Miniature – external thread	24
<b>8417</b>	Miniature – external thread	26
<b>8427</b>	Compact – external thread	26

### BENDING BEAMS

<b>8510/8511</b>		28
<b>8512</b>	S-beam	28

### MULTIDIMENSIONAL LOAD CELLS

<b>8560</b>	Multidimensional	30
<b>85SD-M231</b>	Multi-axis	30

### SPECIAL SENSORS

<b>85SD-F502</b>		32
<b>85SD-F312</b>		32
<b>8400-B001</b>		33
<b>8500-B004</b>		33

<b>Special-design OEM load cells &amp; contract manufacturing strain gage mounting</b> Tailor-made and economic solutions for small-scale to large-scale production	34-35
<b>Comparison chart – sensors in product groups 8.4 and 8.5</b>	36-37
<b>Sensor-signal analysis</b> – the correct interface for every application	38
<b>Sensor electronics</b> – instrumentation amplifiers and sensor interfaces	39
<b>Sensor electronics</b> – digital indicators and calibrators	40
<b>Sensor electronics</b> – process monitoring using process controllers	41
<b>Accessories, calibrated alignment with instrumentation, cable/connector assembly</b>	42
<b>Service and after-sales services</b> – the burster all-inclusive package for peace of mind	43
<b>Calibration</b> – every aspect of calibration, in-house and on-site, DAKS calibration laboratory D-K-15141-01-00	44-45
<b>Glossary/FAQ</b>	46-47



# Compression load cells

FOR STATIC AND DYNAMIC APPLICATIONS.

## MINIATURE COMPRESSION LOAD CELL 8402

The compact design, made possible by a compression measuring element, makes this load cell the popular choice for fitting in tight spaces when the sensor must withstand not only consistently high loads but also sudden impacts at high force. This load cell can also be configured to specific customer requirements to provide the ideal solution for the intended environment.



### Features

- Measuring ranges from 0 ... 1 kN up to 0 ... 100 kN
- Suitable for impact loads
- Standardized output signal

### Highlights

- Miniature dimensions
- Connecting cable suitable for drag chains

### Options

- Can be standardized with different sensitivities
- Connecting cable attached centrally from below
- Form-fitted to prevent rotation

### Applications

- Smart tools for presses and punching machines
- Indirect assessment of quality of manufactured edges by measuring the cutting force at cut edges
- Dies for compacting powdered materials

### Accessories

#### DAkS and factory calibration certificate

Provided by our accredited calibration centre for optimum measurement confidence over the full measuring range

#### Sensor instrumentation

Display/evaluation units, fieldbus modules, complex process control systems supplied ready for use

#### Connectors / connector assembly

Range of connectors fitted, including integral burster TEDS

# Applications

AN IMPRESSIVE FORCE.

## MINIATURE COMPRESSION LOAD CELL 8402

### Measuring the pressing forces of rollers

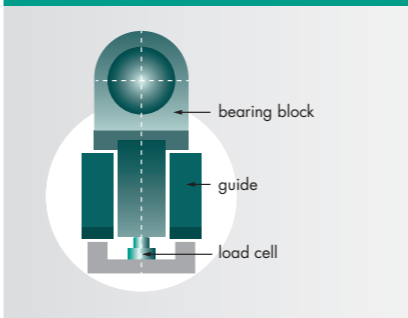

#### Highlights

- Miniature design
- Rigid construction

#### Benefits

- Robust
- Can also tolerate impact loads

The requirement is to measure the pressing forces of rollers, for instance the forces needed to deform sheet metal in steelworks. The load cell must be fitted in the roller bearing blocks such that the sensor can detect the forces in the direction of action of the

rollers. This requires a suitable guide. The load cell must be able to absorb any transient load peaks such as can inevitably occur when starting up the machine or with inhomogeneous material.

### Measuring the punching forces inside the tool

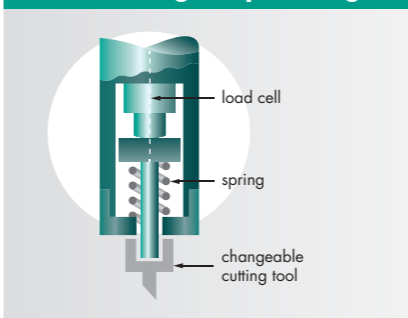

#### Highlights

- Small nominal distance
- Rapidly rising force characteristics

#### Benefits

- Pre-loaded load cell
- Fits into a small space

Inside the tool of a die-cutter is fitted a load cell under spring-loading. The spring force holds the sensor body in place and ensures that all the components contact one another with zero backlash in their direction of action. The load cell itself must occupy the smallest possible space, to prevent weakening the construction of

the tool unnecessarily. Yet at the same time it must be repeatedly capable of absorbing the sudden jumps in force that occur during the machining process. The measurements from the load cell are ultimately an indication of the level of wear to the cutting tool and hence the quality of the punched edges.



USB multi sensor interface



Instrumentation amp 9250



DIGIFORCE® process monitoring



# Compression load cells

FOR STATIC AND DYNAMIC APPLICATIONS.

## SUBMINIATURE COMPRESSION LOAD CELLS 8413/8414

With an overall height of just 3.3 mm, the entire load cell is not much higher than the diameter of its side-mounted connecting cable. Its "niche" is therefore wherever other sensors are too bulky. Thanks to its low weight, the 8413 load cell is equally suited to locations where any additional mass would completely distort the measurement results or the test setup, with a particularly negative impact on moving mechanisms.

Model 8413



Model 8414



### Features

- Measuring ranges from 0 ... 5 N up to 0 ... 5 kN
- Total height 3.3 mm
- Non-linearity 0.25 % F.S.

### Highlights

- Minimum weight 1.2 g
- Connecting cable suitable for drag chains
- Available with mechanical overload protection (8414)

### Options

- Compensated temperature range -55 ... +120 °C
- Vented design for use in a vacuum
- Can be equipped for use on components subject to vibrations

### Applications

- Monitoring the test forces on jigs in precision engineering
- Adjusting and pre-tensioning devices during setup
- Fitting on automatic bonding machines

### Accessories

#### DAkks and factory calibration certificate

Provided by our accredited calibration centre for optimum measurement confidence over the full measuring range

#### Sensor instrumentation

Display/evaluation units, fieldbus modules, complex process control systems supplied ready for use

#### Connectors / connector assembly

Range of connectors fitted, including integral burster TEDS

# Applications

AN IMPRESSIVE FORCE.

## SUBMINIATURE COMPRESSION LOAD CELLS 8413/8414

### Testing the anti-pinch protection in automatic sliding doors or automatic windows

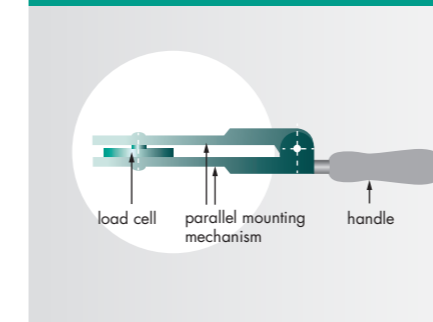

#### Highlights

- Small measuring ranges
- Non-linearity < 0.25 % F.S.

#### Benefits

- Ultra flat design
- Can be used for measurements in narrow apertures

To adjust or test the anti-pinch protection on self-closing sliding doors or automatic windows, a measuring tool is needed that can

also fit into narrow gaps. A tool matching this specification can be produced using the load cell measuring just 3.3 mm in height.

### Annular load cell designed to fit the application using standard sensors

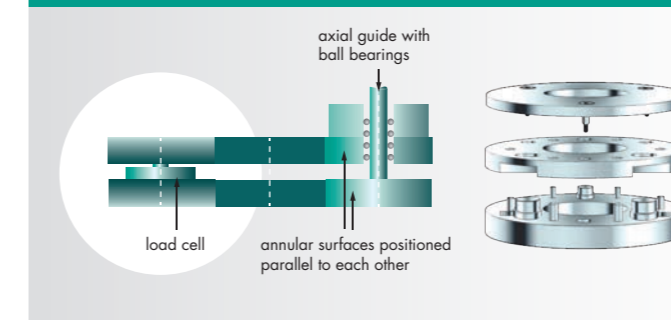

#### Highlights

- Any geometries can be obtained
- Built-in overload protection
- The unit as a whole can be calibrated

#### Benefits

- Economic and quick to produce using standard sensors
- Available ex-stock with rapid supply of spare parts

The need often arises to guide the forces through a load cell via the central axis. Practically any design can be produced, no matter what combination of measuring range and internal diameter of the measuring element is required. The principle is based on two axially aligned annular discs that have the desired internal diameter, with three load cells spaced at 120° around their sur-

face. These load cells have been standardized to output the same electrical signal for easy operation and combined readout by instrumentation amps. The ideal measuring range of the overall system can be achieved by a suitable choice of load cells, and this is adjusted at final calibration.



USB multi sensor interface



Instrumentation amp 9250



DIGIFORCE® process monitoring

# Compression load cells

FOR STATIC AND DYNAMIC APPLICATIONS.

## COMPRESSION LOAD CELL 8526

Thanks to its compact shape and three fixing holes on its underside, the 8526 compression load cell can be used in a variety of applications. Coupled with a wide choice of measuring ranges of 0 ... 100 N up to 0 ... 200 kN, it really can cover a wealth of measurement tasks. The integral load button provides an easy and reliable means of applying the force to be measured.

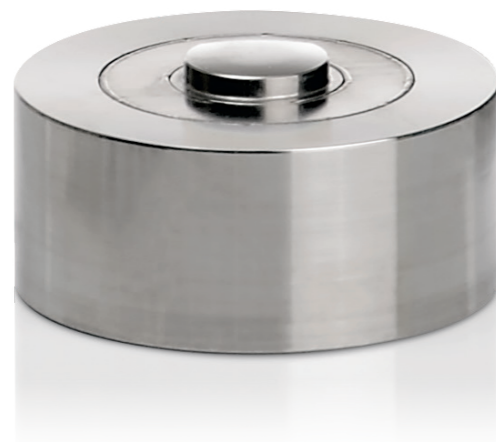

### Features

- Measuring ranges from 0 ... 100 N up to 0 ... 200 kN
- Easy to fit
- Versatile

### Highlights

- Compact design
- Protection class IP64
- Welded construction

### Options

- Standardized nominal sensitivity
- burster TEDS

### Applications

- All forms of test benches
- Reference sensor for comparative measurements
- Integration in machine tools

### Accessories

#### DAkS and factory calibration certificate

Provided by our accredited calibration centre for optimum measurement confidence over the full measuring range

#### Sensor instrumentation

Display/evaluation units, fieldbus modules, complex process control systems supplied ready for use

#### Connectors / connector assembly

Range of connectors fitted, including integral burster TEDS

# Applications

AN IMPRESSIVE FORCE.

## COMPRESSION LOAD CELL 8526

### Monitoring the press-fit force in assembly lines

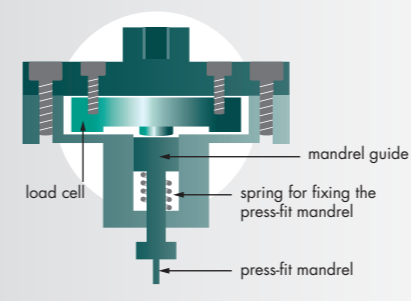

#### Highlights

- Compact design
- Easy to integrate

#### Benefits

- Inexpensive load cell
- Standardized nominal sensitivity for easy replacement

In an automated manufacturing process, small helical springs are pressed onto a component and pre-loaded to a defined force. The 8526 load cell with 0 ... 10 kN measuring range is very compact so can be fitted directly into the tool. Thanks to the tool's

construction, the sensor is easy to access and can be replaced quickly in the event of damage. The tool is designed to absorb inadmissible lateral forces, so that the load cell is loaded solely along the primary axis.

### Monitoring a lever mechanism in a horizontal working position

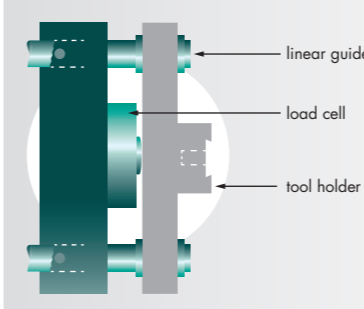

#### Highlights

- Versatile
- Connecting cable suitable for drag chains

#### Benefits

- Multipurpose compression load cell
- Protection class IP64

The task is to test a lever mechanism once installed in a motor vehicle body. This is done by fitting the load cell to a robot arm. Any lateral force resulting from the horizontal working position

and the intrinsic weight of the tool can be absorbed using four linear guides immediately surrounding the load cell.



USB multi sensor interface



Instrumentation amp 9250



DIGIFORCE® process monitoring

# Compression load cells

FOR STATIC AND DYNAMIC APPLICATIONS.

## MINIATURE COMPRESSION LOAD CELLS 8415/8416

With a diameter of barely more than 10 mm, this load cell is by far the smallest, and so also fits in the tightest spaces in tools and instruments. Yet it is just as robust as far larger load cells, and features the same industrial quality. Which means that there are no limits to its potential uses.

Model 8415



Model 8416



### Features

- Measuring ranges from 0 ... 20 N up to 0 ... 5 kN
- Excellent value for money
- Connecting cable suitable for drag chains

### Highlights/options

- Extended temperature range -40 ... +90 °C
- Standardized output signal 1.0 mV/V
- High natural resonance frequency

## MINIATURE RING LOAD CELL 8438

Ring load cells are the ideal, space-saving sensor for measuring axial support forces in the region of ball bearings used to support rotating shafts. They can also be connected to draw plates, however, to ensure a uniform material load and hence guarantee the quality in the manufacture of long parts. This sensor type is often used as the preferred basis for a custom load cell.



### Features

- Measuring ranges from 0 ... 5 N up to 0 ... 200 kN
- Range of internal hole diameters
- Can be configured for numerous custom applications

### Highlights/options

- Measuring element available as diaphragm or compressive body
- Protection class IP65
- Threaded fixing holes in base

### Applications 8415/8416

- Measuring reaction forces in precision engineering
- Force detection in handling equipment
- Laboratory use in assessing contact pressure
- Use as a single element within sensor structures

### Applications 8438

- Force monitoring during riveting
- Measuring contact forces in hydraulic stamps
- Monitoring pulling forces during wire production
- Setting up tools producing radial cutting forces

# Applications

AN IMPRESSIVE FORCE.

## MINIATURE COMPRESSION LOAD CELLS 8415/8416

### Measuring the retaining force of hose clips used for hose assembly

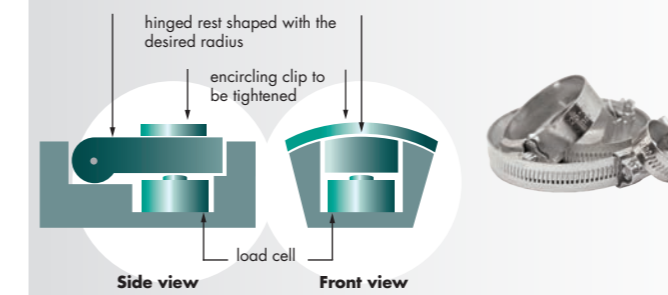

### Highlights

- Diameter of just 10 mm
- Measurement accuracy 0.5 % F.S.

### Benefits

- Its neat tight-fitting design means it can also be used for hose clips of small bending radius

The task is to pre-assemble hose clips on a mandrel of a specified diameter designed to come as close as possible to the final assembly situation, while testing the hose clip function. This function essentially involves transferring a force in a radial direction and thereby guaranteeing a reliable seal between the hose and the

pipe end inside. Not only can the miniature load cells be fitted in mandrels shaped for small clamping diameters but they can also be arranged close enough for several clips to fit side by side on one mandrel for simultaneous testing.

## MINIATURE RING LOAD CELL 8438

### Monitoring the tensions in tie rods

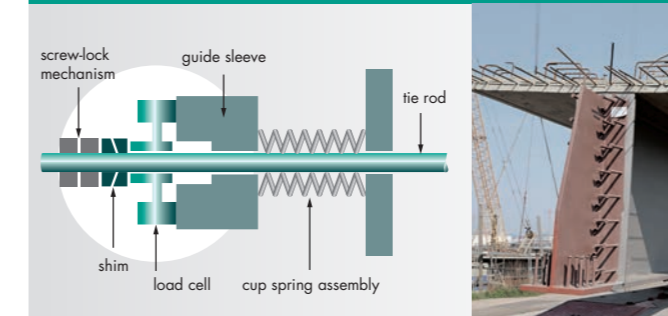

### Highlights

- Easy to fit and space saving
- Robust design
- Internal hole measured to fit

### Benefits

- Good accessibility allowing quick and straightforward re-tensioning

The tensions transferred by tie rods must be monitored constantly during installation, and quickly readjusted if necessary. This requires constant unobstructed access to the screw fastenings using large, typically hydraulic tools. It is a fundamental requirement

on building sites that all components, including the load cell, are robust enough for the environment. Furthermore, it must be easy to remove the measuring device once construction has finished.

### Accessories

DAkkS and factory calibration certificate

Range of cable lengths

Connectors / connector assembly

### Sensor instrumentation

Display/evaluation units, fieldbus modules, complex process control systems supplied ready for use



# Compression load cells

FOR STATIC AND DYNAMIC APPLICATIONS.

## LOW-COST COMPRESSION LOAD CELL 8532

The low-cost 8532 compression load cell is the ideal product for cost-effective measurement of compressive loads. As a product bundle with the 9236 in-line instrumentation amplifier or 9186 DIGILOW digital indicator, this factory-calibrated measurement chain is the stand-out choice where 1% measurement errors are tolerable.

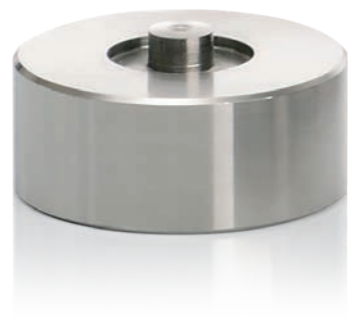

### Features

- Measuring ranges from 0 ... 500 N up to 0 ... 20 kN
- Ultra low-cost

### Highlights/options

- 0 ... ±10 V output signal when bundled with instrumentation amp
- Measured force can be read directly by display device in bundled option
- Factory-calibrated for immediate use

## PRECISION COMPRESSION LOAD CELLS 85043/85073

The 85043 precision compression load cell is ideally suited to applications in critical environmental conditions. A built-in support diaphragm provides maximum protection from lateral forces and hence from faults or measurement errors. In addition, the 85073 precision compression load cell is optimized to achieve a high number of load cycles.



### Features

- Measuring ranges from 0 ... 20 N up to 0 ... 2 MN
- Non-linearity as low as ±0.1 % F.S.
- Up to 10<sup>9</sup> load cycles (85073)

### Highlights/options

- Very low sensitivity to lateral forces
- Protection class IP68
- Extended temperature range of -55 ... +120 °C

### Applications 8532

- Simple test benches and process monitoring tasks across all industries
- Monitoring structures and geological explorations

### Applications 85043/85073

- Harsh environments typical in heavy industry
- Permanent test benches and materials testing machines
- Reference measurements

# Applications

AN IMPRESSIVE FORCE.

## LOW-COST COMPRESSION LOAD CELL 8532

### Checking the tension of a conveyor belt

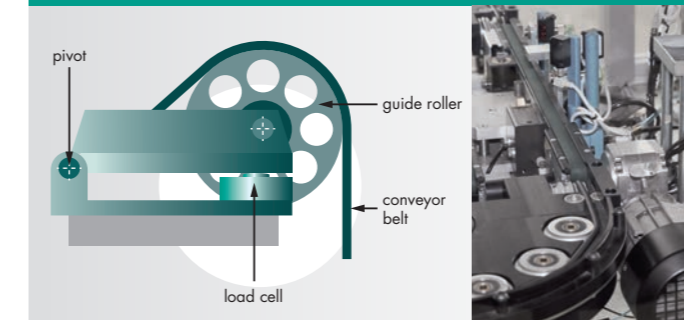

### Highlights

- Inexpensive sensor solution
- Available as product bundle with instrumentation amp

### Benefits

- Load cell can be used in the harshest industrial environments
- Sensor can be replaced quickly
- Drive monitoring and emergency-stop in event of belt tear

The tension of a conveyor belt used in an extremely harsh industrial environment needs to be monitored. If the force signal drops

below a reference value or the belt fails, the drive is switched off immediately and an alarm is output.

## PRECISION COMPRESSION LOAD CELLS 85043/85073

### Monitoring the holding force of an automatic machine saw in a steelwork

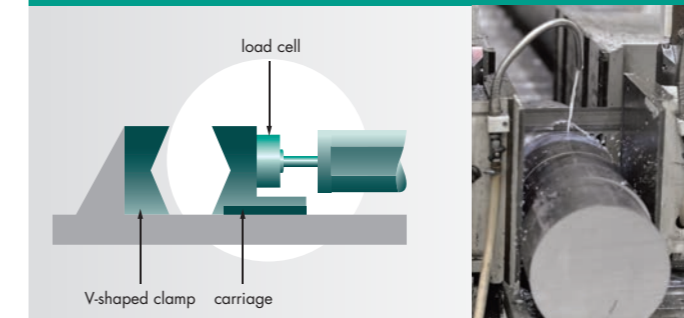

### Highlights

- Operates in an extended temperature range of -55 ... +120 °C
- Protection class IP68

### Benefits

- High stability in the automatic production process
- Long operating life even in very dirty, oily environments

Steel sections need to be sawn to length after rolling. Since the sections may not have cooled down to ambient temperature by this point, the temperature of the load cell can reach 90 °C as a result of radiated heat. A load cell with an extended temperature

range is chosen for monitoring the clamping forces at a V-shaped clamp designed to hold the sections. Lubricants and scale in the sensor's immediate vicinity have no effect on the operation or service life of the load cell.

### Accessories 8532

**9236 in-line instrumentation amplifier** or **9186 DIGILOW digital indicator** as a preconfigured bundle

### DAkKS and factory calibration certificate

Produced by our accredited calibration centre for optimum measurement confidence over the full measuring range

### Sensor instrumentation

Display/evaluation units, fieldbus modules, complex process control systems supplied ready for use

### Accessories 85043/85073

**Connecting cables**

# Compression load cells

FOR STATIC AND DYNAMIC APPLICATIONS.

## HIGH-PRECISION COMPRESSION LOAD CELL 8527

The high-precision compression load cell is the ideal reference sensor for checking and calibrating force measuring equipment and also for providing high-precision measurements in test benches or weighing equipment. Made of high-quality stainless steel, a particular feature of the 8527 load cell is the low non-linearity of no more than 0.05 % F.S.



### Features

- Measuring ranges from 0 ... 500 N up to 0 ... 100 kN
- Maximum non-linearity of 0.05 % F.S.
- Easy to fit

### Highlights/options

- Ultra-high precision
- Optional burster TEDS for portable use with e.g. TRANS CAL 7281

## PRESSES LOAD CELLS 8451/8552

Measuring the process forces arising in manual or automatic presses calls for load cells that can be easily adapted to fit the existing assembly. The 8451 and 8552 presses load cells feature pegs and holes that can be supplied in standard diameters.

Model 8451



Model 8552



### Features

- Low measurement error of 0.5 % F.S. (8451)
- Choice of peg and hole diameter from 8 mm to 16 mm (8552)
- Easy to fit between press ram and tool

### Highlights/options

- Mechanical overload protection up to 10 times the measuring range
- Protection class IP65

### Applications 8527

- Reference measurements on force-application equipment
- Maximum precision in test bench construction, laboratory and production
- Test and analysis systems in all industry sectors

### Applications 8451/8552

- Hand-operated presses on manual assembly benches
- Automatic presses on production lines
- Measuring bending, punching and cutting forces

# Applications

AN IMPRESSIVE FORCE.

## HIGH-PRECISION COMPRESSION LOAD CELL 8527

### Calibrating a hydraulic press using a reference measurement

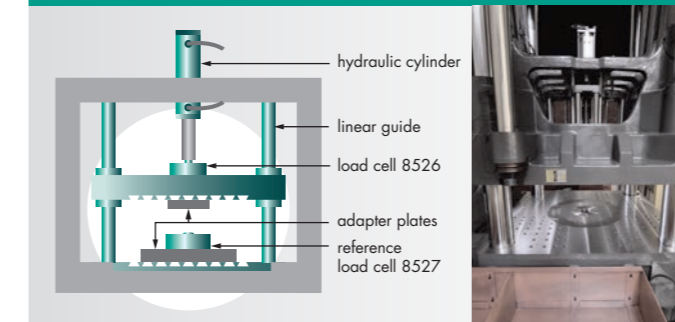

### Highlights

- Ultra-low non-linearity of < 0.05 % F.S.
- Measurement chain includes DAkkS calibration certificate

### Benefits

- DAkkS calibration certificate meets auditing requirements
- Load cell made of high-strength stainless steel for measurements with maximum precision

A hydraulic press is fitted with a load cell for monitoring the pressing force. This sensor must be checked regularly, because the system is operated in shifts under difficult conditions. The only option is to calibrate the sensor in its installed state, because

internal friction forces arising from guides etc. can have an effect on the measurement result. The 8527 load cell, bundled with the TRANS CAL 7281, proves a practical measurement combination for portable use under these circumstances.

## PRESSES LOAD CELLS 8451/8552

### Monitoring the press-insertion force of a ball bearing

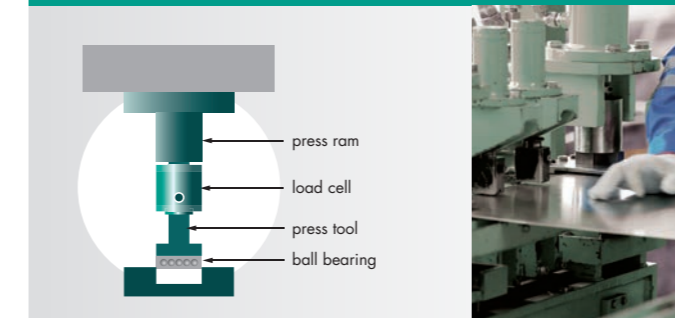

### Highlights

- Comes in a range of peg and hole diameters
- Standard tool holder, suitable for retrofitting

### Benefits

- 5-fold protection in event of temporary static overloads
- Protected against ingress of coolant or lubricant

A ball bearing needs to be press-fitted into a component. Load cell 8552 is used to verify that the bearing has been fitted with the correct force. The sensor can be fitted easily between tool and press ram using a standard tool holder. A visual and acoustic signal from the ForceMaster 9110 is used to indicate that the maximum force has been reached. The load cell is equipped

with burster TEDS, so that sensor settings can be imported into the ForceMaster 9110 without any laborious configuration.

Watch our **How-to-do video** at: [www.youtube.com/bursterVideo](http://www.youtube.com/bursterVideo)

### Accessories 8527

TRANS CAL 7281 mobile testing device

DAkkS and factory calibration certificate

Connectors / connector assembly

### Accessories 8451/8552

ForceMaster 9110, DIGIFORCE® controller

Range of cable lengths

Sensor instrumentation

# Tension and compression load cells

FOR STATIC AND DYNAMIC APPLICATIONS.

# Applications

AN IMPRESSIVE FORCE.

## PRECISION TENSION AND COMPRESSION LOAD CELL 8524

The 8524 precision tension and compression load cell is a highly versatile multipurpose load cell. Tensile and compressive loads can be applied directly into the central internal thread, although it is also possible to fit a load button. Optional mechanical overload protection protects against loads up to 5 times the nominal force. Also available are a pull plate and rod end bearings.



### Features

- Measuring ranges from 0 ... 500 N up to 0 ... 200 kN
- Standardized nominal sensitivity
- Made of high-strength stainless steel

### Options

- Overload protection up to 5 times the nominal force
- Pull plate and rod end bearings
- Non-linearity  $\leq 0.1$  % F.S.

### Highlights

- Connecting cable suitable for drag chains
- Versatile design
- Protection class IP67

### Applications

- All areas of mechanical engineering
- Assembly and joining equipment
- Hydraulic presses
- Measurement of cable strengths

### Accessories

#### DAkkS and factory calibration certificate

Provided by our accredited calibration centre for optimum measurement confidence over the full measuring range

#### Sensor instrumentation

Display/evaluation units, fieldbus modules, complex process control systems supplied ready for use

#### Connectors / connector assembly

Range of connectors fitted, including integral burster TEDS

## PRECISION TENSION AND COMPRESSION LOAD CELL 8524

### Measuring the press force in a hydraulic press

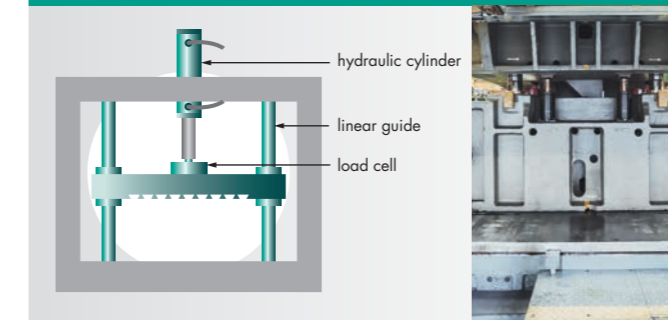

#### Highlights

- Low measurement error of 0.25 % F.S.
- Large choice of different measuring ranges

#### Benefits

- Particularly versatile
- Accessories such as pull plates
- Mechanical overload protection and rod end bearings available

The press force of a hydraulic press needs to be monitored in order to apply the correct process force to the part. The top press table is prevented from tilting by two linear guides. The 8524

load cell, with a measuring range of 0 ... 100 kN, is connected directly to the hydraulic cylinder.

### Using the load cell with pull plate and rod end bearings in lifting gear

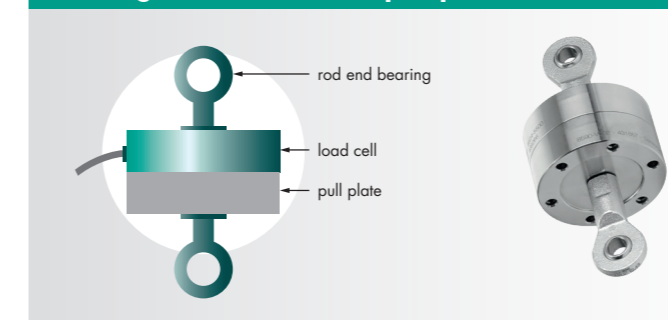

#### Highlights

- Pull plate for directing tension forces via the central internal thread
- Rod end bearings for easy integration in lifting gear

#### Benefits

- Can be suspended easily in the tension line in order to perform the necessary measurements

The 8524 load cell is designed for versatility. For instance it can be combined with an additional pull plate and rod end bearings to create a simple measuring tool for determining loads in lifting

gear. This combination of 8524 load cell and attachments can also be used easily as a torque arm for indirect torque measurement.



**Rod end bearings**  
for applying the force to the sensor

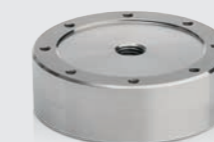

**Pull plate**  
for linear force application



**Load buttons**  
for central application of compressive loads



# Tension and compression load cells

FOR STATIC AND DYNAMIC APPLICATIONS.

# Applications

AN IMPRESSIVE FORCE.

## MINIATURE TENSION AND COMPRESSION LOAD CELL 8435

The 8435 tension and compression load cell can be fitted quickly in almost any situation, taking up practically no space, and offering a technical specification that larger sensors would envy. Thanks to its outstanding price/performance ratio in terms of its mechanical and electrical specification, the load cell finds its niche in products that are produced in relatively large numbers and where margins are tight.



### Features

- Measuring ranges from 0 ... 200 N up to 0 ... 5 kN
- Non-linearity 0.25 % F.S.
- Easy to fit

### Highlights

- Connecting cable suitable for drag chains
- Strong coiled cable section for kink protection
- Rugged housing

### Options

- Nominal sensitivity standardized in the sensor connecting cable
- Pressure equalization hole for use in a vacuum
- Additional protection for the connecting cable

### Applications

- Automatic assembly equipment on production lines
- Friction force test in laboratory equipment
- Holding forces on loading machinery

### Accessories

#### DAkS and factory calibration certificate

Provided by our accredited calibration centre for optimum measurement confidence over the full measuring range

#### Sensor instrumentation

Display/evaluation units, fieldbus modules, complex process control systems supplied ready for use

## MINIATURE TENSION AND COMPRESSION LOAD CELL 8435

### Placing and snap-fitting caps on tubes

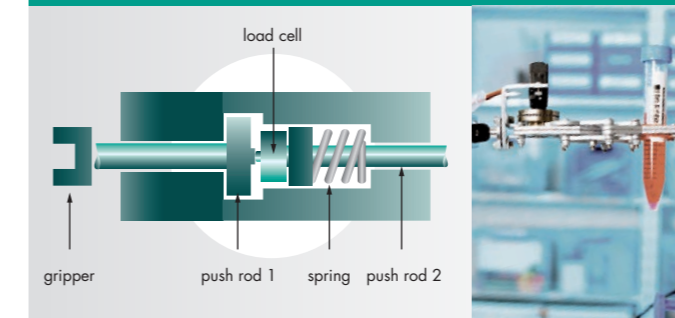

### Highlights

- Same geometry for all measuring ranges
- Good-value load cell

### Benefits

- Can be fitted in small spaces thanks to the sensor housing's flange-type screw-fitting

A gripper mounted on a measuring apparatus is to be used to fit tubes with caps, whose intrinsic weight must not be included in the measurement. The gripper must position, snap-fit and finally twist the cap securely in place. The load cell is fitted in the tool such that it is initially protected against axial overload while also being fully protected against lateral forces loads arising from imprecise centring, weight effects or accelerations on the pivoted

fixing unit. The measurement must reproduce the short snap-fitting event reliably. Decoupling the mechanical connection prevents any torque transfer to the axis of the load cell.

Watch our **Installation video** at:  
[www.youtube.com/bursterVideo](http://www.youtube.com/bursterVideo)

### Measuring the tensions on mounting parts for attaching suspended pipelines

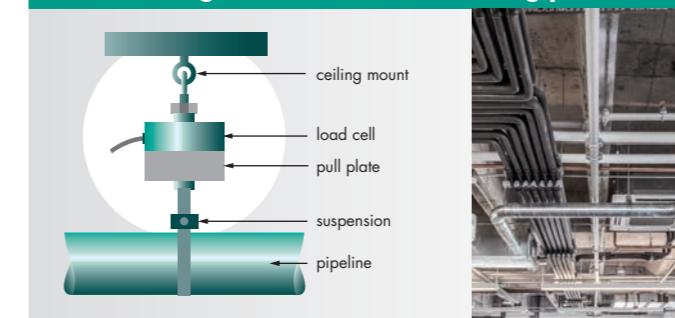

### Highlights

- Coiled cable section to prevent kinks
- Measurement accuracy 0.25 % F.S.

### Benefits

- Pull plate fitting to load cell
- Lightweight construction, so that its intrinsic weight has negligible effect on the measurement

Plastic pipes for carrying liquids and gases around industrial buildings are often suspended under the ceiling structure, preferably with more than one pipe suspended from one fixing point. Trial and error is normally employed to find the ideal position for these fixing points, based on the diameter, length and shape of the pipes, temperature effects and the density of the fluid they

are carrying. In this process, load cells can be used to record the various load conditions, which can be analyzed and included in the installation diagram. The load cells are equipped with burster TEDS and hence can be read repeatedly and successively by the portable indicator with ease.



**Rod end bearings**  
for applying the force to the sensor

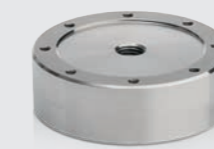

**Pull plate**  
for linear force application



**Load buttons**  
for central application of compressive loads

# Tension and compression load cells

FOR STATIC AND DYNAMIC APPLICATIONS.

# Applications

AN IMPRESSIVE FORCE.

## TENSION AND COMPRESSION LOAD CELL 8523

The 8523 tension and compression load cell features an outstanding price/performance ratio. Made of high-quality aluminium, the load cell can be easily fitted in practically any situation thanks to its central internal thread and holes in the outer flange.

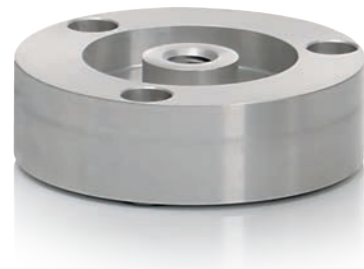

### Features

- Measuring ranges from 0 ... 20 N up to 0 ... 5 kN
- Excellent price/performance ratio
- Protection class up to IP64

### Highlights/options

- Load cell rests on three knife-edge bearings for exact positioning
- Standardized nominal sensitivity

## PRECISION LOAD CELLS 85041/85075

The 85041 precision load cell is ideally suited to applications in the harshest environments in which tensile and/or compressive loads need to be measured. It is resistant to bending and torsional forces of up to 40% of the sensor measuring range. The 85075 load cell is particularly popular in applications in which the number of load cycles is high.



### Features

- Measuring ranges from 0 ... 20 N up to 0 ... 2 MN
- Non-linearity as low as  $\pm 0.1$  % F.S.
- Up to  $10^9$  load cycles (85075)

### Highlights/options

- Very low sensitivity to lateral forces
- Protection class IP68
- Extended temperature range of  $-55 \dots +120$  °C

### Applications 8523

- Measuring contact forces and compressive loads
- Measuring tensions in a variety of applications
- Low budget for measurement task

### Applications 85041/85075

- Monitoring press-insertion forces
- Measuring support forces
- Assembly monitoring

## TENSION AND COMPRESSION LOAD CELL 8523

### Simple tension measurement on a quick-release axle for mountain bikes

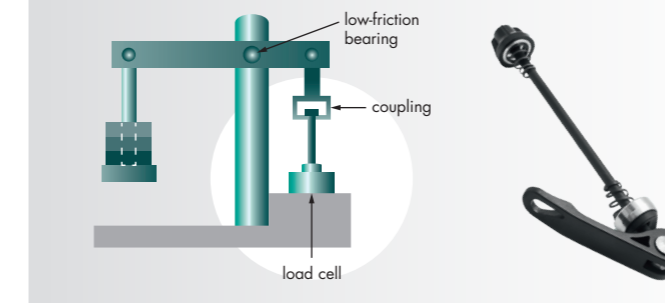

### Highlights

- Load cell has excellent price/performance ratio
- High measurement accuracy

### Benefits

- Versatile load cell, with same dimensions for 0 ... 20 N up to 0 ... 500 N
- Standardized nominal sensitivity for easy replacement at the analysis unit

Pretesting of a carbon quick-release axle for mountain bikes needs to be performed without having to invest in a costly test system. A 8523 load cell provides the answer. The test setup in the form of balancing scales is equipped with a long balance arm in order

to be able to add weights comfortably by hand. To avoid lateral forces on the load cell, it is important that the balance arm is set exactly horizontal and mounted in friction-free bearings.

## PRECISION LOAD CELLS 85041/85075

### Quality-assured monitoring of spring characteristics

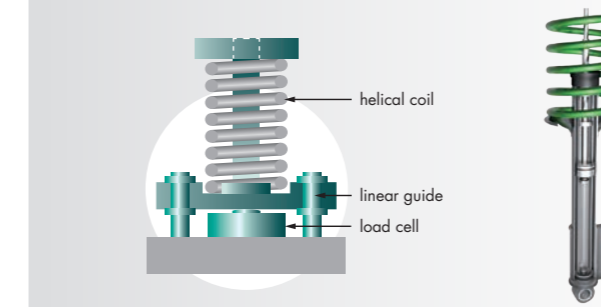

### Highlights

- Up to  $10^9$  load cycles
- Low-level lateral forces have only a negligible effect on the measurement quality

### Benefits

- Excellent long-term stability
- No resonance phenomena thanks to very high resonance frequency

The task is to test on a test bench, helical coils for suspension struts of commercial vehicles. First, 100% of the nominal force is applied to the springs, and then the spring is loaded in accordance with a realistic force curve. The measurement displacement

is measured in parallel in order to obtain a force/displacement curve as the spring characteristic, which at the end of the process is only allowed to deviate from specified values within a certain tolerance.

### Accessories 8523

**Connectors / connector assembly**  
**Range of cable lengths**

**DAkkS and factory calibration certificate**

### Sensor instrumentation

Display/evaluation units, fieldbus modules, complex process control systems supplied ready for use

### Accessories 85041/85075

#### Connecting cables

Available in a variety of lengths and types depending on the instrumentation to be connected to the sensor

**Load buttons, pull plates, rod end bearings**

# Tension and compression load cells

FOR STATIC AND DYNAMIC APPLICATIONS.

# Applications

AN IMPRESSIVE FORCE.

## MINIATURE TENSION AND COMPRESSION LOAD CELLS 8431/8432

This series is one of our most precise and yet toughest miniature load cells. The 8431 and 8432 load cells include options otherwise only available in far bigger sensors. Their built-in support diaphragms and bidirectional overload protection reduce the extra design work involved in many applications around how to apply the force to the load cell. This not only cuts the overall weight of the structure drastically but also dispenses with friction-generating guidance mechanisms. These advantages are ultimately reflected in the quality of the measurement results.

### Model 8431



#### Features

- Measuring ranges from 0 ... 10 N up to 0 ... 100 kN
- Non-linearity 0.15 % F.S.
- Extremely easy to fit

#### Highlights

- Available with bidirectional overload protection (8432)
- Insensitive to lateral forces thanks to support diaphragms
- Detachable threaded adapter
- Rugged welded construction

#### Accessories

##### DAkS and factory calibration certificate

Provided by our accredited calibration centre for optimum measurement confidence over the full measuring range

##### Sensor instrumentation

Display/evaluation units, fieldbus modules, complex process control systems supplied ready for use

### Model 8432



#### Options

- Submersible cable watertight up to 35 bar
- Compensated temperature range from -55 °C ... +200 °C
- Pressure equalization hole for operating in a vacuum
- Standardized nominal sensitivity

#### Applications

- Measuring the forces on tools used in custom machine-making
- Measurements on torque arms
- Devices for measuring tactile forces on operating controls

##### Connectors / connector assembly

Range of connectors fitted, including integral burster TEDS

##### Rod end bearings

for applying the force to the sensor



## MINIATURE TENSION AND COMPRESSION LOAD CELLS 8431/8432

### Measuring the joining forces during assembly of small electric motors

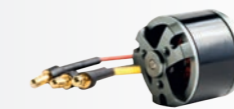
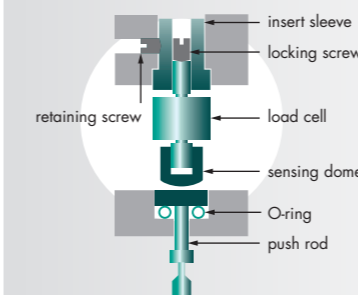

#### Highlights

- Non-linearity < 0.15 % F.S.
- Easy to fit inside the tool

#### Benefits

- No friction-generating guides needed thanks to integral support diaphragms

A multipurpose tool is fitted with several load cells, operated by push rods. First the tool presses the separate parts together. Next, specially designed flanging is reshaped in order to join the parts securely together. The 8431 load cell is ideal for fitting in the limited space available and for the required easy replacement.

Thanks to its built-in support diaphragms, there is no need for any additional guidance mechanism for transferring the force.

Watch our **Installation video** at: [www.youtube.com/bursterVideo](http://www.youtube.com/bursterVideo)

### Fitting the hands on analog instrument spindles

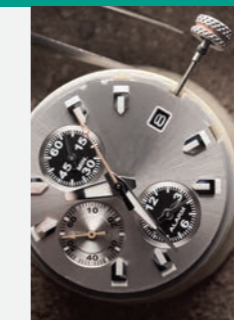
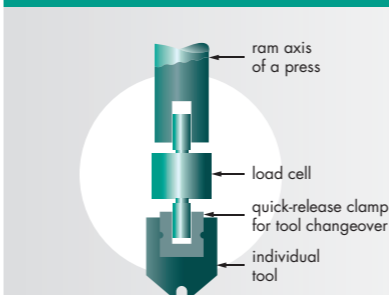

#### Highlights

- Built-in overload protection
- Load cell insensitive to lateral forces

#### Benefits

- Small measuring ranges available
- Detachable threaded load adapter

In instrument-making and precision engineering, sensitive parts such as hands and needles need to be fastened to spindles. Handling must be delicate enough to avoid damaging these intrinsically lightweight components yet firm enough to ensure they sit securely in place. The 8432 load cell chosen here, with

integral mechanical overload protection, is designed to measure small loads in a very sturdy package. In addition, any lateral forces that inevitably arise in this process and produce a bending moment on the sensor axis have no impact on the measurement accuracy.



USB multi sensor interface



Instrumentation amp 9250



DIGIFORCE® process monitoring



# Tension and compression load cells

FOR STATIC AND DYNAMIC APPLICATIONS.

# Applications

AN IMPRESSIVE FORCE.

## MINIATURE TENSION AND COMPRESSION LOAD CELL 8417

The 8417 load cell is the smallest sensor there is for measuring tensile and compressive loads. Its diameter measures just 10 mm, while the fixing threads at each end are only size M3. With a commensurately low weight of just 3 g, its uses extend to mass-critical applications.



### Features

- Measuring ranges from 0 ... 10 N up to 0 ... 5 kN
- Connecting cable suitable for drag chains, also suitable for frequent movement
- Welded stainless-steel construction

### Highlights/options

- Long threaded adapters
- Standardized output signal can be provided in the cable
- Vacuum-compatible design with vented sensor housing
- Special calibrations available

## TENSION AND COMPRESSION LOAD CELL 8427

A compact yet really sturdy load cell for tension and compression loads, where the focus has deliberately been on price/performance ratio. With a range of fixing options, the load cell can be used practically anywhere. The choice of possible attachments reduces costs and the volume of spares that must be kept. Thanks to its modular design, customer requirements can be satisfied quickly using a range of threaded fastenings.



### Features

- Measuring ranges from 0 ... 100 N up to 0 ... 10 kN
- Rugged welded construction
- Protection class IP65

### Highlights/options

- Each end fitted with a flange designed for holding with a spanner
- Also available with external thread
- Range of fixing options

### Applications 8417

- Multipurpose food packaging machinery
- Measuring internal gear-change forces of friction bearings fitted in transmissions
- Test setups and endurance testing for mechanical grippers

### Applications 8427

- All areas of mechanical engineering
- Automated production plants
- Test equipment for safety areas on rail vehicles

## MINIATURE TENSION AND COMPRESSION LOAD CELL 8417

### ↘ Pulling forces and transmitted forces in bowden cables

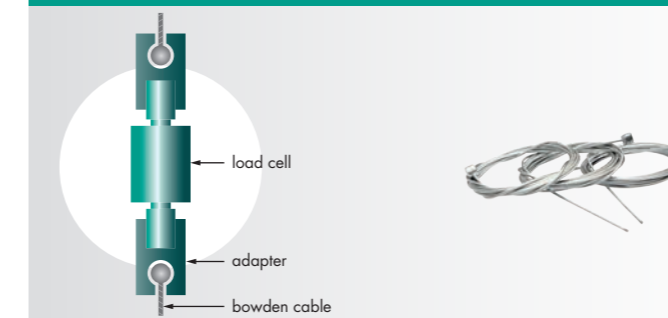

### Highlights

- Ultra-compact design
- Long fixing thread

### Benefits

- Thanks to its low intrinsic weight, the sensor does not alter the measurement result in whatever position it is fitted

The transmitted forces in vehicle bowden cables need to be measured in test beds. These forces vary according to length, pre-tension and radius of curvature of the installed cable. Extreme temperatures also affect the measurement. In addition, the tests must measure the long-term performance of the cables and the at-

tenuating effects of the wires on transmission of the pulling forces. The 8417 load cell is ideal for this purpose because its negligible intrinsic weight means it has no effect on the measurement and hence does not distort the result. This is particularly important when the dynamic behaviour of fine wires needs to be assessed.

## TENSION AND COMPRESSION LOAD CELL 8427

### ↘ Fitting the interior trim to vehicle doors

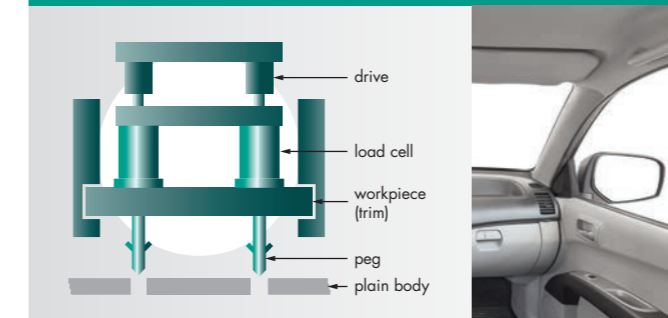

### Highlights

- Good price/performance ratio
- Can be integrated in robot tools

### Benefits

- Rapid response to very short events
- Robot-friendly cable

Handling robots fit pre-assembled internal door trims into the plain body coming from the paint shop. These units don't just consist of the visible shell, but also contain parts such as locks, window winders, controls and, for rear-door trim, also windscreen wiper motor and lighting. The load cells monitor the force with which the individual snap-fit pegs are inserted into the sheet me-

tal, and the actual snap-fit event. Above every position of a snap-fit peg, inside the interchangeable robot tool is a load cell with the correct measuring range, ensuring complete data is obtained on the fastening quality at each of the 16 fixing points. The load cell is fitted with a cable suitable for robot use, being designed to withstand numerous movements and friction in the drag chain.

### Accessories 8417 and 8427

DAkkS and factory calibration certificate

Range of cable lengths

Connectors / connector assembly

Rod end bearings

Sensor instrumentation

### Accessories 8427

Threaded pins

Load buttons



# Bending beam load cells

FOR STATIC AND DYNAMIC APPLICATIONS.

# Applications

AN IMPRESSIVE FORCE.

## BENDING BEAM LOAD CELLS 8510/8511

With their low overall height, bending beam load cells are used wherever limited space rules out other forms of load cells. Protection against mechanical overload can be implemented very easily thanks to the bending-beam design with its relatively large measurement deflection. These load cells are also easy to fit. The dual-beam construction helps to ensure that the sensor surfaces move parallel to one another with no angular offset.

Model 8510

Model 8511

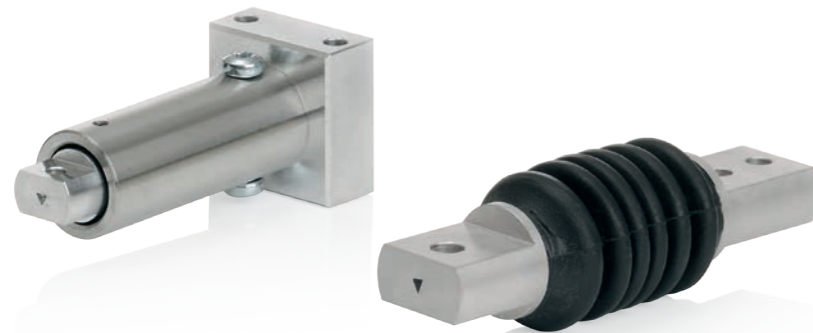

### Features

- Measuring ranges from 0 ... 1 N up to 0 ... 2 kN
- Non-linearity as low as 0.1 % F.S.

### Highlights/options

- With built-in overload protection (8510)
- Straightforward force application
- For tensile and compressive loads

## S-BEAM TENSION AND COMPRESSION LOAD CELL 8512

The compact range of S-beam dual-beam sensors with easy fitting options and excellent price/performance ratio are suitable for use not only in quality and materials control but also in highly price-sensitive applications such as the medical and pharmaceuticals industry.



### Features

- Measuring ranges from 0 ... 20 N up to 0 ... 880 N
- Non-linearity < 0.1 % F.S.
- Ultra-slim design

### Highlights/options

- High number of load cycles > 10<sup>6</sup>
- Standardized nominal sensitivity
- Connecting cable suitable for drag chains

### Applications 8510/8511

- Testing actuating elements
- Weighing technology
- Measuring reaction torques

### Applications 8512

- Materials testing machines
- Test and analysis systems in the pharmaceuticals industry
- Measuring loads in cable systems

## BENDING BEAM LOAD CELLS 8510/8511

### Testing micro-switches during continuous mass production

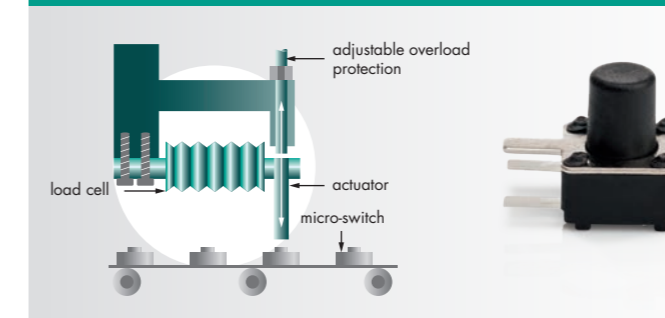

### Highlights

- Non-linearity as low as 0.1 % F.S.
- Low overall height

### Benefits

- Easy to provide overload protection
- Can measure tensile and compressive loads

The requirement is to test the characteristic curve of micro-switches on the production line. This quality assurance measure requires a load cell with overall height and overload protection, which safeguards the load cell from damage caused by an inadmissibly high operating force in a faulty switch. A set-screw limiting the travel of the 8511 load cell provides overload protection. The

measurement displacement is measured alongside the operating force, and the force/displacement curve analyzed by a DIGIFORCE® 9311 connected to the sensors.

Watch our **Installation video** at:  
[www.youtube.com/bursterVideo](https://www.youtube.com/bursterVideo)

## S-BEAM TENSION AND COMPRESSION LOAD CELL 8512

### Force measurement in tablet hardness-testing equipment

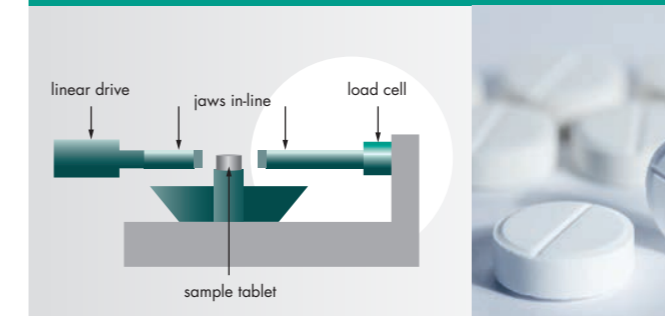

### Highlights

- Long-lasting, versatile sensor
- Very high output signal

### Benefits

- Excellent value for money
- Overload stop along primary axis

Equipment for tablet hardness testing must follow strict standards and specific test sequences to measure the relevant breaking forces. Reproducible testing of the breaking force (0 ... 220 N) of tablets of various diameters can be achieved thanks to clever jaws for holding the tablet under test, a precision linear drive and an S-beam load cell of optimum shape and functional design. The force is applied to the custom, easy-to-fit S-beam load cell via a

horizontally operating precision linear drive and jaws in-line with the force path. Thanks to the excellent measurement accuracy and ultra-low initial response force, it is possible to detect even the smallest forces, for instance the on-touch force, or identify a range of tablets under test, allowing a single load cell to perform reliable testing. The instrumentation can indicate actual, mean or maximum values depending on the selected measurement mode.

### Accessories

- DAkkS and factory calibration certificate
- Range of cable lengths

- Connectors / connector assembly
- Sensor instrumentation

# Multi-axis load cells

FOR SIMULTANEOUS FORCE MEASUREMENT IN MORE THAN ONE SPATIAL DIMENSION.

# Applications

AN IMPRESSIVE FORCE.

## MULTIDIMENSIONAL TENSION AND COMPRESSION LOAD CELL 8560

The sophisticated structural design of the multidimensional tension and compression load cell delivers outstanding mechanical properties, for instance very high nominal forces ratio, high overload capability and low cross-talk, making this sensor an excellent basis for measurements in a huge range of applications.



### Features

- Measurement of  $F_x$ ;  $F_y$ ;  $F_z$  (depends on type)  
Measuring ranges from 0 ... 250 N up to 0 ... 50 kN
- Easy to fit design
- Low cross-talk

### Highlights/options

- Compensated temperature range from -40 ... +120 °C
- Custom designs available on request
- Extremely high factor for the rated load ratio  $F_z/F_x$
- CANopen

## MULTI-AXIS LOAD CELL 85SD-M231

Sensors fitted in tyre-testing and balancing machines must be able to measure force in the X- and Y-directions. The vital factor is that the measurement directions have little impact on each other, i.e. cross-talk is low. The load cells must tolerate a high number of load cycles and be extremely accurate. The load cells can be fitted by service staff and the standardized nominal sensitivity ensures reliable readings.



### Features

- Measuring ranges X:  
0 ... 1000 lbs up to 0 ... 2000 lbs
- Measuring ranges Y:  
0 ... 500 lbs up to 0 ... 1000 lbs
- Other custom measuring ranges available on request
- Easy to fit and replace

### Highlights/options

- Up to 100 million load cycles
- Low cross-talk < 0.5 % F.S.
- Non-linearity < 0.1 % F.S.
- Standardized nominal sensitivity

### Applications 8560

- Medical technology
- Automated handling and robotics
- Sorting systems
- Multi-dimensional applications in R&D

### Applications 85SD-M231

- Testing car and truck tyres
- Balancing tasks

## MULTIDIMENSIONAL TENSION AND COMPRESSION LOAD CELL 8560

### ↘ $F_x/F_y$ force measurement on the gear stick

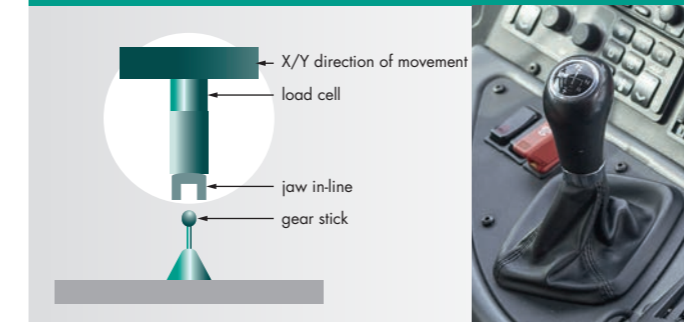

### Highlights

- Measurement performed far from where the force is applied
- Extremely large ratios for nominal forces up to a factor of 50

### Benefits

- Built-in instrumentation amplifier
- Ultra insensitive to lateral forces

Mechanical endurance testing of a truck gear stick involves taking the gear stick through more than several million load cycles in a temperature range of -40 ... +120 °C. The forces exerted in the X- and Y-directions during each gear-change operation are measured continuously by a two-axis load cell and documented by a central data acquisition unit. The effect of any lateral forces

in the Z-direction up to 6 times the nominal force is minimized thanks to an extremely robust construction, ensuring long-term stability of the measurement. Significant changes, which might arise from wear or different actuating forces, are analyzed to determine the resultant implications for gear-change performance and durability.

## MULTI-AXIS LOAD CELL 85SD-M231

### ↘ Measuring two-dimensional forces in order to balance car tyres

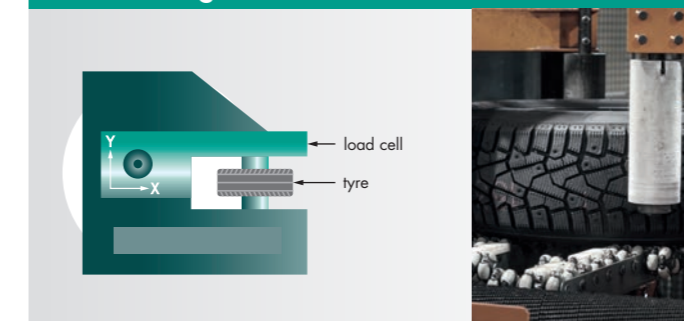

### Highlights

- Force X = 1000 lbs, Force Y = 500 lbs
- Low cross-talk
- Designed to withstand numerous load cycles

### Benefits

- Very low non-linearity for each measurement axis
- Ultra-rugged construction

A manufacturer of car tyre balancing machines requires a load cell that can detect force in various measuring ranges in the X- and Y-directions. In addition, the cross-talk between the two

measurement signals must be very low. At the customer's request, a special X/Y load cell was designed for this measurement task.

### Accessories 8560

Range of cable lengths

Connectors / connector assemblies

DAkkS and factory calibration certificate

### Sensor instrumentation

Display/evaluation units, fieldbus modules, complex process control systems supplied ready for use

### Accessories 85SD-M231

Connecting cables



# Special-purpose load cells

FOR STATIC AND DYNAMIC APPLICATIONS.

## PRECISION RING COMPRESSION LOAD CELL WITH LARGE INTERNAL HOLE 85SD-F502

The 85SD-F502 precision ring compression load cell is used when available installation space is limited but a load cell with a large internal hole and high measuring range is needed. The load cell is mounted on an even surface and the force is applied via the hole to the two annular end faces.

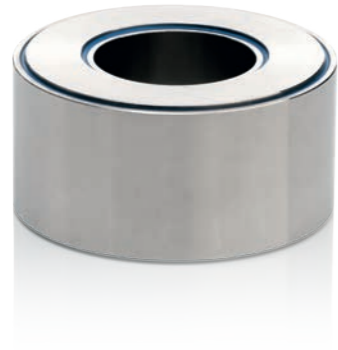

### Features

- Measuring ranges from 0 ... 20 kN up to 0 ... 2 MN
- Exceptionally rigid
- Low non-linearity < 0.15 % F.S.

### Highlights/options

- Large internal hole in a compact overall size
- Optionally available with second, redundant measuring bridge

### Applications

- Measuring compressive loads in rolling mills
- Measuring spring characteristics
- Materials testing machines

### Accessories

- DAkkS and factory calibration certificate
- Choice of cable lengths
- Connectors / connector assembly
- Sensor instrumentation

## PRECISION TENSION AND COMPRESSION LOAD CELL 85SD-F312

The 85SD-F312 tension and compression load cell is based on the shear beam principle. Instead of a diaphragm, the inner and outer flanges are connected via various beams, on which strain gages measure the shear force. This design allows a very high number of load cycles (fatigue rated). This construction also permits a very short measurement deflection of just 50 µm.



### Features

- Measuring ranges from 0 ... 1 kN up to 0 ... 2 MN
- Non-linearity as low as 0.05 % F.S.
- Up to 10<sup>9</sup> load cycles

### Highlights/options

- Shear-beam principle with "fatigue rated" design
- Optionally available with second, redundant measuring bridge
- Suitable for highly dynamic systems

### Applications

- Aircraft engineering and testing
- Materials-testing machines
- Multipurpose sensor for measuring compression/tension forces

### Accessories

- DAkkS and factory calibration certificate
- Connecting cables
- Load buttons
- Pull plates
- Rod end bearings

## PEDAL LOAD CELL 8400-B001

This sensor is a device designed to measure pedal forces. This is done by attaching the 17 mm flat load cell directly to the pedal, which can be arranged suspended or upright. Fitted with several strain gages, the sensor is able to minimize the effect of any lateral forces. The cable is designed to handle frequent movements to ensure even greater benefits in practice.



### Features

- Measuring ranges from 0 ... 1 kN up to 0 ... 2 kN
- Central threaded fastening for attachments
- Non-linearity 0.25 % F.S.

### Highlights/options

- Load cell with two calibrated measuring ranges
- Temperature compensated range -30 ... +60 °C
- Protection class IP67

### Applications

- Measuring all forms of pedal forces
- Robust in design with sealed construction, this sensor is suitable for actual use in the vehicle not just on the driving simulator in the lab

### Accessories

- DAkkS and factory calibration certificate
- Choice of cable lengths
- Connectors / connector assembly
- Sensor instrumentation

## PLATFORM LOAD CELL 8500-B004

The 8500-B004 platform compression load cell was developed specifically to withstand loads up to several times the measurement range. Thanks to its special shape and small dimensions, the load cell is also suitable for fitting in guide channels of a belt drive. This practically rules out any damage to the load cell, for instance caused by accidentally dropped loads in logistics applications.



### Features

- Measuring range 0 ... 400 N
- Low overall height of 15 mm

### Highlights/options

- Extremely high overload protection up to 20 times the nominal force
- Shock-proof and wear-resistant
- High number of load cycles up to 10<sup>8</sup>

### Applications

- Overload protection on conveying systems
- Installation in test systems for improving the comfort of wearing orthopaedic aids
- Weighing goods for transport

### Accessories

- DAkkS and factory calibration certificate
- Range of cable lengths
- Connectors / connector assembly
- Sensor instrumentation

# OEM – Your wish is our command

**TAILOR-MADE OEM LOAD CELLS, SPECIAL DESIGNS AND STRAIN GAGE ATTACHMENT.**

## OEM – BECAUSE YOUR PROJECT IS UNIQUE

We offer you **all-round expertise to find the perfect answer to your measurement problem**. Standard sensors are not always the best possible solution for your application – different technical and commercial considerations often mean that the custom design is the better option.

burster has decades of experience in developing and producing load cells, and uses this expertise to focus on the essentials of a project. This is crucial to finding, in partnership with you, **precise and efficient solutions**, both for small production runs and for large-scale production.

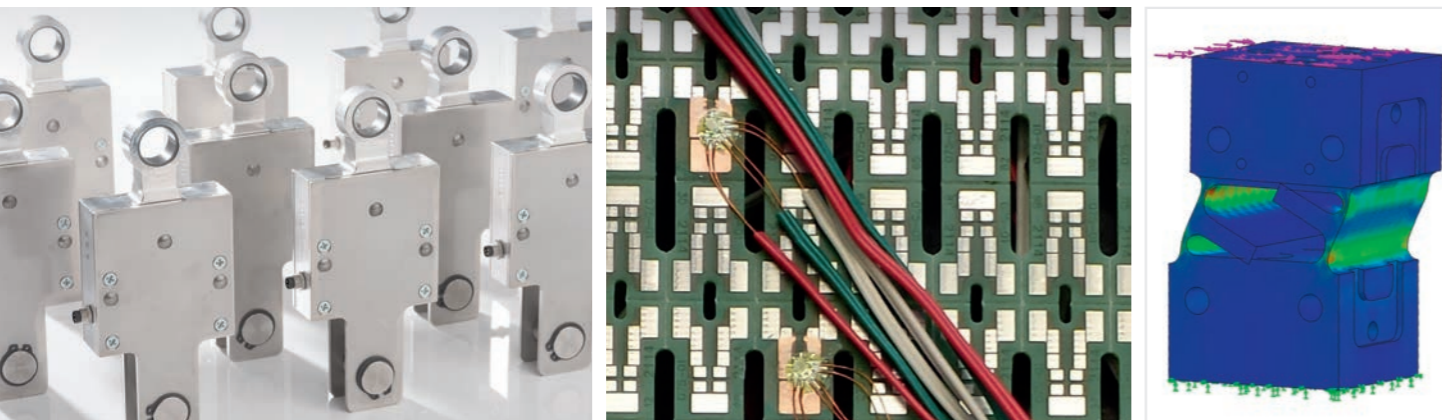

## WE EXAMINE PRECISELY WHAT MEETS YOUR NEEDS BEST

It starts with your inquiry. We then use our years of experience in countless successful customer applications to analyze and assess your requirements, assisted by advanced design, development and analysis tools such as FEM and Rapid Prototyping. Whatever the job – whether designing a sensor from scratch, applying strain gages, possibly including modifications to a part or tool, or customizing standard products – you will always benefit from streamlined and efficient procedures.

## PRECISE, COST-EFFECTIVE, FAST – YOUR SOLUTION IS ON ITS WAY

In the shortest possible time, we provide you with a feasibility analysis, an authoritative proposed solution or even the first prototype. You can rely on our comprehensive quality management system throughout the process, as we keep a sharp eye on delivery times, stock-keeping, packaging and documentation.

## GOOD TO KNOW - EVERY DETAIL COUNTS

We need as much information as possible about your project so that we can engage with you completely and produce tailor-made results: a detailed description of the application as well as technical data such as specifications, drawings or samples are all relevant. It is also helpful to our work to know your commercial and administrative context. The better the underlying data, the smoother the project will run, the more successful the result.

# Perfectly fitting

**THREE CHALLENGES YOU CAN HAPPILY PASS OVER TO US.**

## DESIGNING YOUR CUSTOM LOAD CELL FROM SCRATCH

Totally new designs tend to be used when standard sensors are not suitable for reasons of geometry, measurement specifications or cost.

### Your technical benefits

- Custom load-cell solutions to fit your measurement and mechanical requirements
- Low integration costs achieved by providing the optimum design
- Creation of 3D-models and release drawings including technical specification



### Your administrative benefits

- Feasibility check and quotation typically within 5-10 working days after clarification of product specification
- Samples supplied from 4 weeks after receipt of detailed specification and customer order
- Economic solutions, from one-off products to mass production

## MODIFIED STANDARD SOLUTIONS – STANDARD LOAD CELLS WITH CUSTOMIZATIONS

Modified standard load cells are chosen for a measurement project when most of the existing sensor performance can be re-used and minor technical modifications to the standard sensor are sufficient.

### Your technical benefits

- Choice of cable designs and lengths, modified measurement specifications, minor mechanical adjustments to the standard product
- Creation of 3D-models and release drawings including technical specification

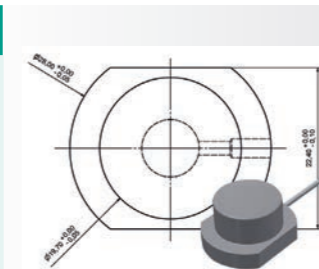

### Your administrative benefits

- Feasibility check and quotation typically within 5-10 working days after clarification of product specification
- Short delivery times depending on level of customization and customer order
- Economic solutions, from small-scale to mass production

## APPLYING STRAIN GAGES TO TOOLS OR COMPONENTS SUPPLIED BY YOU

Strain gages are applied to positions specified by the customer on their original parts. Typically these are existing parts on which forces or moments are meant to be measured. We are also able to post-machine customer components to provide the optimum position for applying the strain gages for best measurement results.

### Your technical benefits

- Components up to 550 x 400 x 400 mm in size can be handled
- Strain gages can be applied to **aluminium, steel or stainless steel**
- Fits your measurement and mechanical requirements
- Usually no structural changes needed to the machine

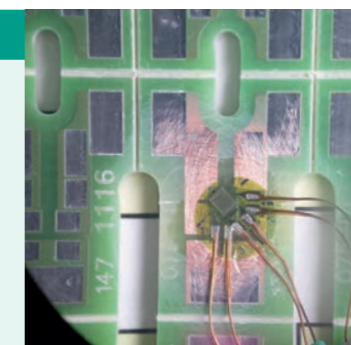













### Your administrative benefits

- Feasibility check and quotation typically within 5-10 working days after clarification of product specification
- Rapid machining and/or express strain gage attachment in a few working days
- Economic solutions from one-off products to mass production, including procurement and cost optimization

# Comparison chart

ALL LOAD CELL RANGES AT A GLANCE.







MODELS	8402	8413	8414	8415	8416	8417
Figure						
Page	6 - 7	8 - 9		12 - 13	12 - 13	26 - 27
Description	Miniature compression load cell	Subminiature compression load cells with overload protection		Miniature compression load cell	Ultra-miniature compression load cell	Miniature tension and compression load cell
Non-linearity	0.5	0.25	0.25	0.5/0.75	0.5	0.5
Measuring Range smallest: largest:	0 ... 1 kN 0 ... 100 kN	0 ... 5 N 0 ... 5 kN	0 ... 5 N 0 ... 100 N	0 ... 200 N 0 ... 5 kN	0 ... 20 N 0 ... 5 kN	0 ... 10 N 0 ... 5 kN
Special Features	Large measuring ranges combined with small dimensions, short measurement deflection, high number of load cycles	Ultra-small external dimensions, extremely low overall height with temperature compensation, high resonance frequency (up to 167 kHz)	Overload protection included in ultra-small external dimensions	Economical flat disc sensor, external diameter 20 mm	Extra-small load cell, external diameter 10.6 mm and height 4.5 mm	Just 10 mm in diameter and 6.5 mm in height, easy to fit using external thread
Main Application Fields	Measurement of press-insertion forces on longitudinal and lateral press-fit seatings, measurement of force in punching machines, chucks and tools	Where space is tight for measuring contact and friction forces and testing pushbuttons & switches	Automatic production lines, for testing joints and smooth running	Contact forces, positioning forces, pressing forces in machines	Instrument-making, microsystem technology, production lines, handling equipment	Micro-mechanics, actuator systems, switches, bowden cables





MODELS	8510	8511	8512	8523	8524	8526
Figure						
Page	28 - 29	28 - 29	28 - 29	22 - 23	18 - 19	10 - 11
Description	Miniature bending beam load cell	Bending beam load cell	S-beam tension and compression load cell	Tension and compression load cell	Precision tension and compression load cell	Compression load cell
Non-linearity	0.25	0.1	0.1	0.15	0.1	0.25
Measuring Range smallest: largest:	0 ... 1 N 0 ... 20 N	0 ... 5 N 0 ... 2 kN	0 ... 20 N 0 ... 880 N	0 ... 20 N 0 ... 5000 N	0 ... 500 N 0 ... 200 kN	0 ... 100 N 0 ... 200 kN
Special Features	Mechanical overload protection, very small size	Insensitive to sources of parasitic errors and lateral forces	High number of load cycles > 10 <sup>6</sup> , connecting cable suitable for drag chains	Economical multipurpose aluminium sensor, lightweight, compact	Robust load cell for industrial and laboratory applications, available with overload protection	Compact design combined with high measuring ranges, protection class IP64, internal thread for easy fixing
Main Application Fields	Test equipment (switches, pushbuttons), contact forces, packaging and adhesive technology	Weighing equipment, filling scales, water level gages, filling equipment	Automated tool testing, test and analysis systems in the pharma industry, measuring loads in cable systems	Forces in rods, bars and frameworks, counting and test scales	Monitoring jointing processes, torque measurement via force x lever length	Contact forces, pedal forces, filling systems, presses

- Options:**
- Extended temperature range from -55 °C ... +200 °C
  - Hermetically sealed version (IP68) / submersible cable
  - Standardization of nominal sensitivity

- Built-in amplifier
- Integrated cable, including range of lengths for drag chain use
- Vacuum equalization hole

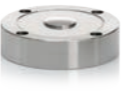
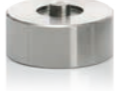
- Load application parts
- Pull plates

8427	8431	8432	8435	8438	8451/8552
					
26 - 27	24 - 25		20 - 21	12 - 13	16 - 17
Tension and compression load cell	Miniature tension and compression load cells		Tension and compression load cell	Miniature ring load cell	Presses load cells
0.7	0.15	0.15	0.25	1.0	0.5
0 ... 100 N 0 ... 10 kN	0 ... 10 N 0 ... 100 kN	0 ... 5 N 0 ... 2 kN	0 ... 200 N 0 ... 5 kN	0 ... 5 N 0 ... 200 kN	0 ... 100 N 0 ... 100 kN
Each end fitted with a flange designed for holding with a spanner, also available with external thread, choice of fixing options	Versatile precision sensor, insensitive within limits to lateral forces, bending and torsion moments, IP68, temperature from -55 °C ... +200 °C	Like model 8431, but with overload protection for both tensile and compressive loads	Stainless steel tension and compression load cell for OEM applications	Central through-hole, low overall height	Easy to fit directly, factor of 10 mechanical overload protection, attachment for mounting displacement sensor actuator
All areas of mechanical engineering, automated production, test equipment for safety areas on rail vehicles	Push and pull rods, balancing scales, electromagnets, baffles	Production and test lines, but also laboratory equipment	Press-insertions, forming operations, proportioning, connector tests	Measurement of screw-connection force, contact forces of bolts, threaded rods, cutting forces	Manual presses and automatic pressing stations

8527	8532	8560	85041/85043 85073/85075	855D-M231
				
16 - 17	14 - 15	30 - 31	22 - 23 / 14 - 15	30 - 31
High-precision compression load cell	Low-cost compression load cell	Multi-axis tension and compression load cells	Precision tension and compression load cells	Multi-axis load cell
0.05	1	0.5	0.1	0.1
0 ... 500 N 0 ... 100 kN	0 ... 500 N 0 ... 20 kN	0 ... 250 N 0 ... 50 kN	0 ... 20 N 0 ... 2 MN	X: 0 ... 2000 lbs Y: 0 ... 1000 lbs
High-precision sensor, protection class IP65, easy to fit	Particularly economical load cell with IN-LINE amplifier, output 0 ... 10 VDC	Compensated temperature range -40 ... +120 °C, can be customized, extremely high factor for the nominal force ratio Fz/Fx, CANopen	Precision sensors, hermetically sealed, very low sensitivity to lateral forces, also suitable for highly dynamic applications	Up to 100 million load cycles, low cross-talk < 0.5 % F.S., standardized nominal sensitivity
As a reference in precision measurements in both laboratory and industry	Weights, press-insertions, feed forces	Medical technology, automated handling and robotics, sorting systems, multi-axis use in R&D	Presses, containers (e.g. silos), materials testing, calibration	Testing and balancing car and truck tyres

- Services:**
- In-line calibration with external instrumentation
  - Cable/connector assemblies
  - DAkKS/factory calibration certificate

- Custom full scale calibrations
- User training and commissioning training
- Online retrieval of calibration and test certificates

You can find further information on our load cells at [www.burster.com](http://www.burster.com). Our website contains detailed technical **data sheets**, **installation instructions** and **CAD data** available for download.

You can also use the website comparison tool to compare directly the sensors you are specifically interested in, and contact us **online with your questions**.

Visit us at our website or call us! We are happy to help.

- CAD data
- How-to-do videos
- Application advice



# Sensor instrumentation for every application

MEANINGFUL ANALYSIS OF YOUR SENSOR SIGNALS.

## WITHOUT ANALYSIS, SENSOR SIGNALS REMAIN DATA STREAMS WITHOUT VALUE

Without the correct signal amplification, post-processing, visualization, analysis and evaluation in the context of your requirements, sensor signals simply remain useless streams of data. **The success of your process monitoring set-up ultimately depends on these signal processing steps.**

Depending on the application and degree of automation, you are faced with issues of networking, speed, accuracy, interfacing, integration and economic viability. **High performance and optimum utilization** of your processes are essential if they are to meet future requirements reliably and flexibly.



## THE CORRECT INTERFACE FOR YOUR APPLICATION

burster offers you the **full spectrum of sensor signal acquisition and analysis tools, from simple digital indicator to high-end process controller.** We use our decades of experience to give you precisely the advice you need.

Take advantage of our applications advice at the start of a project, or our optimization suggestions for on-going processes. If decision is made for sensor and relevant electronics, we will of course be happy to align the sensor with electronics and supply you with the full measurement chain. DAkKS and factory calibration certificate available on request.

Using high-quality sensors and appropriate instrumentation from burster your business benefits from quality, flexibility and efficiency and the confidence to operate in fast-changing markets. The burster comprehensive package gives you peace of mind, because you can rely on precise, rapid measurement data acquisition.

## RELIABILITY AT YOUR FINGERTIPS – burster PLUG & PLAY



Smart interaction is the key to success in a world where sharing information is ever more important. Interconnecting people, machinery and products in fully or semi-automated production processes is a challenging and demanding reality. Engineers must design processes to be easy to monitor, quantify, reproduce and analyze while aiming for ever greater reliability.

Sensor-specific data is stored in the sensor connector using innovative burster TEDS technology. The analysis instrument reads this sensor data and uses it for the automatic configuration of the evaluation electronics. This not only protects against setting incorrect parameters but makes it easier to change sensors while saving time and money spent on configuration.

## INSTRUMENTATION AMPLIFIERS AND SENSOR INTERFACES

burster amplifier products are used wherever sensor signals from strain gage, potentiometric or DC/DC sensors need to be converted into standard voltage or current signals and supplied to a PLC or other host systems for further analysis. These products will be indispensable in **future production environments** where, in addition to their traditional role of amplifying and transferring sensor signals, they will need to perform this task in the context of **Industry 4.0** using **flexible fieldbus connections via modern interfaces** such as i.e. PROFINET. burster also offers a high-performance Plug&Measure solution for PC-based measurement tasks.

## THE NEW INSTRUMENTATION AMPLIFIER GENERATION 9250/9251

- Ready to use with any make of sensor for your measurement needs, manufacturer independent
- Ultra-fast pushbutton configuration
- Automatic sensor recognition due to burster TEDS
- Suitable for force, pressure, displacement, rotational speed and torque measurements, including combined measurements
- Synchronous export of up to 8 measurement channels via the bus controller
- Supports Ethernet-based fieldbuses as PROFINET, EtherCAT, EtherNet/IP or I/O interface
- Tare facility via pushbutton or I/O signals for each 9250 amplifier
- Up to two real-time signals/limit switches per amplifier module
- Versatile configuration using DigiVision PC software via USB port

NEW



## Sensor interfaces 9206 and 9236 with Plug&Measure concept.



### 9206 USB multi sensor interface for strain gage sensors

- Plug&Measure version or four-channel version
- Simple connection via PC USB port
- 24-bit resolution
- High-speed measurement of up to 1200 readings/s
- Measurement accuracy of at least 0.01 %
- LabVIEW and DLL drivers available free of charge

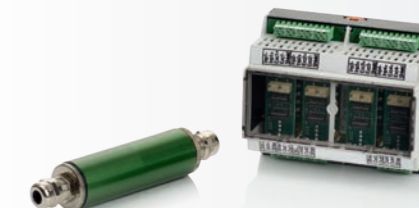

### 9236 multichannel amplifier for strain gage sensors

- Tubular housing, DIN-rail mounting or PCB version
- Voltage output 0 ... ±5 V / 0 ... ±10 V
- Protected against reverse connection and short-circuit
- Also available as circuit board without housing
- Multi-channel capability
- High protection class up to IP67

# Sensor instrumentation for every application

## MEANINGFUL ANALYSIS OF YOUR SENSOR SIGNALS.

### DIGITAL INDICATORS AND CALIBRATORS

**Digital indicators receive the measurement signals from your load cells and convert them for presenting on a display.** Depending on their range of functions, these instruments already help you to analyze your measurement signals and can transfer the evaluated measurement data to the higher-level control environment. Limit-setting and visual alarms on the display are convenient features for handling sensor signals. Portable indicators and calibrators provide a straightforward means for you to perform your self-governed device testing and calibration directly in your production environment without lengthy production downtimes.

The **9163 digital indicator** covers a wide range of applications in which process values need to be measured, displayed, analyzed and transferred to higher-level control systems.



#### SENSORMASTER 9163

- For force, pressure or torque measurements using strain gage sensors
- For distance or angle measurements with potentiometric or DC/DC sensors
- Measurement accuracy of 0.1 % and sensor-specific linearization
- Range of mathematical functions (e.g. differential measurement)
- OK/NOK feedback on multicolour display and via 4 alarm limit outputs
- High sampling rate (500/s)

The multipurpose **7281 TRANS CAL testing device** can be used wherever there is a need to perform high-precision, on-site calibrations of sensing components used in equipment such as presses, torque tools or pressure-regulating systems.



#### TRANS CAL 7281 mobile high-precision calibrator and testing device for mechanical and electrical measurements

- Compatible sensors: Strain gage/standard signal  $\pm 5$  V,  $\pm 10$  V, potentiometric sensors
- Device test: strain gage simulator up to  $\pm 50$  mV/V
- Easy configuration via burster TEDS
- Excellent linearity with an error of just  $\pm 0.001$  %
- Storage of up to 16 measurement programs
- Data-logger for up to 30.000 measured values
- DAkKS/factory calibration certificate available for the instrument or the entire measurement chain including 8527 reference sensor (optional)

### ADJUSTMENT FOR USE WITH EXTERNAL INSTRUMENTS

When planning to connect display and analysis instruments to your load cell, it is essential to calibrate the system, i.e. align the sensor with the instruments, to ensure correct measurement readings and correct output scaling. We are happy to perform this **adjustment of sensor and indicator** for you, and supply a **traceable adjustment report** with this service. We can also accommodate personal adjustment requirements. This service means that your measurement system is immediately ready for use, saving you precious time.

### PROCESS MONITORING CONTROLLER

Process controllers are used when **detailed process analysis for continuous optimization and zero-fault monitoring** of the produced parts is needed in addition to sensor signal amplification, visualization and recording. The powerful burster controllers are designed for the demands of an exacting production system usually involving partial or full automation. A vast range of applications can be analyzed and monitored thanks to high-speed and synchronous measurement data acquisition and a wealth of measurement and evaluation techniques. These tools provide the user with detailed process information. The **smart process monitoring systems** visualize, analyze and evaluate quality-relevant process parameters, and can transmit the results **via the latest communications interfaces**. **Ethernet-based fieldbus systems** such as PROFINET transfer process results and status messages to higher-level controllers in real time. Whatever the movement or joining system – pneumatic, hydraulic or servo-electric – burster process controllers have the versatility to integrate with all forms of motion technology.

**DIGIFORCE®** monitors processes in which precisely defined functional relationships need to be demonstrated between two or more measured quantities of the process. Recording, visualizing and evaluating the X/Y curve allow 100% monitoring of process quality, ensuring that the production step and every single produced part are checked.

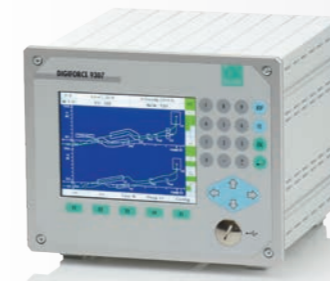

#### DIGIFORCE® 9307

- Greatest precision for the toughest demands
- Simultaneous monitoring of two synchronous processes
- 128 measurement programs for a large variety of parts
- High measurement accuracy 0.05 % F.S. possible at 10 kHz sampling rate
- Intelligent signal sampling through combination of  $\Delta t$ ,  $\Delta X$ ,  $\Delta Y$
- Ultra-fast evaluation (15 ms) and data transfer for dynamic measurements
- Fieldbus data logging in real time
- USB service interface on the front
- Automatic sensor recognition due to burster TEDS



#### DIGIFORCE® 9311

- Simple, quick setup on colour display with touch operation
- 16 measurement programs
- USB service interface on the front
- Fieldbus data logging in real time
- Display and analysis of last 50 measurements
- Universal multi-range measurement channels
- Quick USB data logging
- Automatic sensor recognition due to burster TEDS

The **ForceMaster 9110** has been developed specifically for monitoring manual lever presses. So easy to operate, it lets any user monitor the press operation successfully.



#### ForceMaster 9110

- Excellent value "Plug & Work" complete system
- Easy auto-configuration with automatic setting of the evaluation tools
- Smart Card system for manipulation free configuration and storage of settings
- Acoustic and optic error indication
- Data logging on USB flash drive (optional)
- PLC sequence control function (optional)
- Includes analysis and configuration software
- Automatic sensor recognition
- Hub and other component counters

### EXPERTS IN EVERY FIELD

**burster instrumentation amplifiers, digital indicators, calibrators and process controllers are incredibly versatile.** They enjoy the trust of countless users in industries with extremely high quality standards; industries such as mechanical and plant engineering, automation and the automotive sector and its suppliers. And in increasingly important markets such as medical technology, biotechnology, e-mobility and drive technology, burster systems are already making a vital contribution to quality assurance.



# Accessories to equip you for every situation

## SENSORS AND A HOST OF OPTIONS.

### ALL ABOUT THE SENSOR

For more specialized measurement applications, we can offer you special options over and above our wide range of load cells in a variety of designs and measurement ranges. Furthermore, we also keep a large choice of accessories to provide the best load-cell fit in the very wide-ranging installation situations presented by our customers. Here you will find just some of our most popular products.

#### Load application adapters



- Attachment for fitting the 8431 load cell (small measuring ranges) in presses
- Attachment for the displacement sensor actuator bracket from set 5501-Z002
- Available with internal thread, M4 (5501-Z014) or M5 (5501-Z015)

#### Load buttons



- Central application of load for load cells with internal thread
- Hardened to HRC58
- Underside of button polished to ensure it is perpendicular to its axis
- M4 to M36 thread available

#### Adapter sets 8552



#### For fitting load cells/displacement sensors to manual presses:

- Different sets available for load cells 8552 and 8451
- For attaching potentiometric displacement sensors to a press head
- Multipurpose parts
- A range of assembly options for the individual parts gives a choice of mounting positions for the displacement sensor
- Mounting diagram and all fixing screws included in set
- How-to-do video showing you how to use the adapter set can be found at [www.youtube.com/bursterVideo](http://www.youtube.com/bursterVideo)

#### Rod end bearings



- Optimum load application
- Corrects alignment errors
- Suitable for very high dynamic and static loads
- With internal or external thread
- Made of stainless steel

#### Pull plate



- Fitted to sensor to ensure axial application of load
- Suitable for tensile and compressive loads
- Pull plate has same external diameter, height and internal thread as the associated sensor
- Pull plate ready-fitted in factory, the calibration report applies to the complete assembly

### ADJUSTMENT FOR USE WITH EXTERNAL INSTRUMENTS

When planning to connect display and analysis instruments to your load cell, it is essential to adjust the system, i.e. align the sensor with the instruments, to ensure correct measurement readings and correct output scaling. We are happy to **perform this adjustment of sensor and indicator** for you, and supply a **traceable adjustment report** with this service. We can also provide adjustment services tailored to your specific needs. We ensure the measurement system is ready for use, leaving you valuable time to spend on other tasks.

### CABLE/CONNECTOR ASSEMBLY

**burster load cells come with a connecting plug or have a permanently connected cable.** For sensors with a plug we offer a range of connecting cables designed for the process environment (e.g. suitable for drag chains, suitable cable length) and fitted with a mating connector for the particular instrument required.

# Customer Services

## AT YOUR SERVICE!

### KEEPING THE BIG PICTURE IN MIND

We think that high-quality after-sales service is also part of a truly **comprehensive solution** in measurement technology. Which is why burster also offers a **complete service package** around sensors and sensor electronics as well as measurement, test and calibration equipment. Modular elements for planning, implementation and operation cover all relevant aspects of your project; from identifying characteristics through to calibration of the finished system, from optimization through maintenance to repair.

### REPAIRS

Experts will deal with your problem quickly and professionally. Repairs come with a **24-month guarantee**. Calibration and firmware update if appropriate for the sensor and accessories can also be done.

Check online at [www.burster.com](http://www.burster.com) to find your regional contact who will consult and support you individually.

### EXPERT APPLICATION SUPPORT

Given the huge variation in installation and environmental conditions, ensuring that force measurements are precise depends on applying a wealth of technical understanding and application experience to **assessing the entire process chain** of our customers. Whatever support you may need, from measurement-problem analysis through optimization advice of your on-going processes to commissioning and recalibration, experienced engineers and technicians can help.

### APPLICATION TRAINING/ COMMISSIONING

In structured and efficient **training units designed for commissioning engineers, service staff and production personnel**, your staff learn how to integrate and use sensors and instruments effectively in your process environment. In these training sessions we look specifically at your application. We can also provide this support worldwide.

### MORE SERVICE COMPONENTS AND PRODUCT DETAILS ON OUR WEBSITE [www.burster.com](http://www.burster.com)



- In the Service login area you can access your **calibration certificates and test reports 24/7** wherever you are
- The product cockpit contains all the important **information about the product** at a glance
- In just a few steps you can integrate the free **CAD data** for our load cells and process instrumentation into your **CAD design**
- Details for reaching your **direct contact**
- The **download menu** provides access to all product-related files such as **data sheets, user manuals, brochures, videos** and much more

We also provide very helpful videos containing **how-to-do instructions and examples of different sensor installation set-ups**. They provide clear answers to frequently asked questions.

Our **How-to-do video** for mounting a load cell and displacement sensor on manual presses is available at: <https://goo.gl/kkRTk5>





# Calibration services in manufacturer quality

CERTIFIED QUALITY WITH DAkkS/FACTORY CALIBRATION AND TEST CERTIFICATES.

# Flexible service that fits your business

AT YOUR SERVICE!



## PROVIDING TAILORED CALIBRATION SERVICES

As a manufacturer of sensors and measuring systems, burster also features a calibration laboratory accredited to DIN EN ISO/IEC 17025:2005 for the measured mechanical quantity of force.



## IN-HOUSE CALIBRATION SERVICES

For force as the measured quantity, we offer not only test & alignment reports and factory calibration certificates but also the option of a German-accredited DAkkS calibration certificate. burster's fast and efficient calibration service delivers outstanding reliability, accuracy, rigour and traceability for every calibration.

Sample of Calibration Services	Measuring Range	Test & Calibration Certificate	Factory Lab	DAkkS Lab
<b>Force (compressive load DIN EN ISO 376)</b>				
Load cell and force measuring chain	20 N	■	■	■ *
	100 N ... 500 N	■	■	■
	1 kN ... 2 kN	■	■	■ *
	5 kN ... 50 kN	■	■	■
	100 kN ... 2 MN	■	■ *	■ *
<b>Force (tensile load DIN EN ISO 376)</b>				
Load cell and force measuring chain	1 N ... 50 kN	■	■	■ *
	100 kN ... 1 MN	■	■ *	■ *

\* external partners

### The calibrations carried out include the following services:

- Assessing whether your test and measuring equipment is suitable for calibration
- Performing a calibration
- Documenting the calibration with a factory/DAkkS calibration certificate
- Labelling the calibration items in accordance with ISO 17025 or German DKD-5 requirements

Should it prove during our calibration-suitability check that an adjustment is necessary, we perform this adjustment prior to calibration in close consultation with you.

## TAKE ADVANTAGE

You want to be sure that your technical planning is cost-effective and on schedule without the administrative bother of handling your recurring calibration jobs. Then take advantage of our extremely attractive range of calibration offers! We make sure our service meets your needs in terms of schedule, requirements and level of calibration service.

As a German-accredited DAkkS calibration laboratory and manufacturer, we are at your service for calibration, testing and adjustment of your test and measurement equipment in accordance with relevant standards or your own requirements, either in our

own laboratory or at your site. We can provide the optimum calibration service for practically any task.

Check online at [www.burster.com](http://www.burster.com) to find your regional contact who will consult and support you individually.

## ON-SITE CALIBRATION

Make use of our years of experience to perform regular testing and calibration at your site.

- You expect your test equipment to be monitored in accordance with ISO 9001?
- You don't have the resources to dismantle the machinery/equipment for calibrations?
- You want to keep your machinery downtimes to the minimum?

### Our on-site calibration service includes:

- Checking your test or measuring equipment
- Calibration to traceable reference standards
- Providing calibration certification including labelling the calibrated equipment
- Adjustment of amplifiers and measuring systems

## START SELF-GOVERNING YOUR NEEDS WITH OUR SMART CALIBRATION SOLUTIONS

If for any reason an on-site service through us or our partners isn't possible, we offer you some very attractive alternatives to help you calibrate your force measurement system yourself.

### Compact and user-friendly portable load-cell calibrator 72KME

- Force measuring ranges from 0 ... 50 kN
- System accuracy of 0.3 % F.S.
- Full range of accessories, calibration software, reference measurement chains with DAkkS calibration certificate

### Portable reference force measuring chain including DAkkS certificate 72-REF

- 12 force measuring ranges from 0 ... 20 N up to 100 kN
- Maximum, traceable precision

## TRANS CAL 7281 PRECISION CALIBRATION IN YOUR HANDS



Our unique mobile high-precision calibrator and testing device is the smart, robust and traceable answer to your calibration requirements.

TRANS CAL 7281 allows mobile calibration by yourselves on site, with a high degree of accuracy and without needing to dismantle equipment.



Reference measurement chain in combination with a reference sensor



Device test/strain gage simulator  
Infinitely adjustable simulation values: up to ±50 mV/V, up to 10 VDC  
Measurement:  $U_{supply}$  up to 10 VDC



Sensor test  
 $R_r$ ,  $R_a$ , Shunt,  $R_{ISO}$

**Adjustment of measuring instrument** Adjusting a measuring instrument involves setting the top and bottom calibration value and scale value. The actual zero (no-load) signal from the sensor must be subtracted when setting the calibration values. The instrument is adjusted to work correctly with the selected sensor.

**Calibration resistor (shunt)** During shunt calibration, a precision resistor (calibration resistor, also known as a shunt) is connected in parallel with one leg of the load-cell bridge circuit. This precision resistor is used to deliberately detune the measuring bridge and hence produce a calibration offset. A change in the calibration offset over the lifetime of the sensor can indicate possible sensor damage. Shunt calibration has a tolerance in the single-digit percentage range.

**Characteristic curve deviation** The figure for the characteristic curve deviation takes into account not just the non-linearity but also the load in the descending direction. The curve values are measured between 20 and 100% of the full scale value. The maximum characteristic curve deviation is expressed in % F.S.

**Characteristic sensitivity deviation** Deviation in the sensitivity. Expressed as a %. Typically  $\pm 0.25\%$  for standardized sensors.

**DAkkS calibration certificate** DAkkS is the name of the German accreditation agency. A DAkkS calibration certificate issued by a DAkkS-accredited calibration laboratory is internationally accepted. Calibration is in accordance with DIN EN ISO 376, and hence includes measurement sequences in three different installation positions. 10 levels of force are used in the calibration (10% steps until full scale is reached). The certificate states the relative zero offset, the relative non-linearity, the relative hysteresis, the non-repeatability (in constant installation position), the relative extended comparative precision (for different installation positions) and the DIN EN ISO 376 classification. The certificate also indicates measurement uncertainties for different situations under DIN EN ISO 376. burster runs a DAkkS accredited calibration laboratory in accordance with DIN EN ISO/IEC 17025 and also works with DAkkS-accredited partner laboratories.

**Deflection, full-scale** The full-scale deflection is how far the external load application points on the sensor travel towards or away from each other along the primary axis under the nominal force; value lies in the region of a few  $\mu\text{m}$ .

**Factory calibration certificate** The burster factory calibration certificate provides required information on measurement uncertainty, procedure and traceability both for single sensors and for measurement systems. The test points are selected to define 0%, 20%, 40%, 60%, 80% and 100% of the full scale value. Calibration is carried out for rising and falling tensile and/or compressive load under constant installation position. Factory calibrations can also be performed at test points specified by the customer.

**Maximum operating force** This is the maximum operating force that can be applied to the sensor along its primary axis without causing immediate damage. Within the maximum operating force limit there is a reproducible relationship between load and output signal.

**Nominal force** The maximum force for which the load cell is nominally designed and up to which the manufacturer's technical specification holds.

**Nominal sensitivity mV/V** burster load cells are built on the strain gage principle. Usually four or more strain gages are connected together in a Wheatstone bridge arrangement. This type of design means that the sensors do not output an active voltage signal but a small voltage difference across the bridge circuit. For strain gage sensors, the output signal is heavily dependent on the supply voltage. The output signal, and so the nominal sensitivity, is therefore specified in millivolts per Volt of supply voltage (mV/V) at the sensor output. This parameter is sometimes referred to as "sensitivity" for load cells.

**Nominal temperature range** Ambient temperature range in which the load cell stays within the tolerances of the temperature dependent technical data.

**Non-linearity/linearity error** The non-linearity or linearity error defines the maximum deviation of a characteristic curve of a load cell from the ideal straight line; always expressed as a percentage of full scale (% F.S.) and measured for increasing load. The curve values are measured between 20 and 100% of the full scale value.

**Non-repeatability in constant installation position** The non-repeatability in constant installation position specifies the precision with which individual measured values in separate series of measurements can be reproduced. The non-repeatability is measured for the load cell under constant installation position and is expressed in % F.S.

**Operating temperature range** The ambient temperature range in which the load cell can be operated (but under larger tolerances) without any noticeable significant changes to its characteristics when operated again in its nominal temperature range.

**Overload burst** The load in the primary axis of the load cell above which irreversible mechanical damage to the load cell can be expected.

**Percentage of full scale (% F.S.)** Unless otherwise stated, measurement errors are expressed in percentage of full scale (% F.S.).

**Relative hysteresis** Hysteresis is the maximum difference between measurement signals obtained when a load is increasing and a load is decreasing. To measure the hysteresis, a load applied to the sensor is incremented in steps until the nominal force is reached and then decremented in identical steps; the output value is read at each step and evaluated after deducting the no-load signal. The maximum relative hysteresis is given in % F.S.

**Sensitivity** The difference between the output signal at nominal force and no-load, with the sensor in its installed situation.

**Standardization** Standardization involves adjusting the sensors to give a defined (standardized) sensitivity, i.e. all the sensors always output the same signal. This can be necessary when sensors need to be read in series or in parallel on an indicator and there is no burster TEDS facility available.

**Temperature effect on zero output** The change, referred to the nominal sensitivity, in the no-load signal of the load cell due to a change in the ambient temperature of 1 K over a defined temperature range once steady-state, zero-gradient conditions are established. Expressed in % F.S./K.

**Temperature effect on nominal sensitivity** The change, referred to the nominal sensitivity, in the sensitivity of the load cell due to a change in the ambient temperature over a defined temperature range once steady-state, zero-gradient conditions are established. Expressed in % F.S./K.

**Test and calibration certificate** Every product comes with a free test and calibration certificate that complies with the ISO 9001 test equipment monitoring requirements. The test and calibration certificate is confirmation that the product concerned complies with all the rated and maximum values, but does not include a recorded series of measurements.

**Test certificate** A test certificate is supplied with a measurement chain comprising load cell and amplifier/measuring instrument as evidence for the customer that the chain has been aligned correctly.

## FAQ – COUNT ON burster TO PROVIDE THE FACTS

### → Do lateral forces, torsion moments and shear forces affect the measurement result?

In principle, strain gage based load cells must be protected from what are known as parasitic loads. These loads primarily have a negative effect on the measurement result but can also damage the sensor. burster provides special sensors having a certain degree of resistance to these forces. It is also possible to find a solution by modifying the sensor surroundings.

### → Overload protection for sensors. What is its purpose and how does it work?

In certain applications it can be useful to use load cells that have mechanical overload protection. Overload protection is optionally available for some sensors or already built into the design (e.g. 8552, 8432). Depending on the sensor, the overload protection kicks in at 130% of the nominal force and is effective up to 500% of this value.

### → Do load cells need to be fitted under pre-load?

In general, burster load cells do not need to be fitted under load, i.e. pre-loaded. Depending on the type of sensor, however, a small pre-load may be advisable in order to keep the sensor securely in place. In addition, any potential sudden loads can and must be avoided by providing a small pre-load.

### → How should the load be applied to the sensor?

The load must be applied to the load cell solely along the primary axis. First and foremost, forces that are not parallel to this axis result in unpredictable errors in the measurement signal but in the worst case may even cause irreversible damage to the sensor. If applying the load exactly on-axis is not possible, then some special burster load cells such as 8431 or 850XX can be used with permitted external forces. The preferred route is to avoid these forces by a suitable structural design. Some load cells are designed with a convex load button or alternatively can be fitted with one. The measurement load must be applied to this load button via a flat, hardened surface (at least HRC60). This surface must never be concave or convex.

### → Is it OK to change the load on a load cell suddenly?

It is best to avoid sudden changes to the load on a load cell. It can result in irreparable damage to the sensor even if the applied load is below the full scale value. If the sensor has suffered a sudden impact load, you should consult us about the sensor model and measuring range. Removing a load suddenly from load cells is less critical than applying a sudden impact load.

### → What must be taken into account when connecting load cells in parallel?

It can make sense in some applications to connect individual load cells in parallel and measure a summed load (for example weighing equipment). For a plausible measurement signal, all the characteristics of the sensors, for instance nominal sensitivity, input and output resistances, must be identical. Standardized load cells of the same type are therefore best suited here. Caution: the temperature of the sensors must be the same at all the measurement points. When selecting the sensors and the measuring instrument, it is important to check that this

instrument can supply the necessary excitation current for the parallel-connected sensors.

### → Do load cells need an instrumentation amplifier?

burster load cells are built on the strain gage principle. The Wheatstone bridge arrangement composed of individual strain gages has only a low output signal of a few mV. For sensors of this design, the output signal is heavily dependent on the supply voltage (mV/V). This means that an instrumentation amplifier is needed not only to supply the sensor with a constant supply voltage, but also to convert the output signal from the sensor into an output signal that the customer can use, for example 0 ...  $\pm 10$  V or 4 ... 20 mA. burster digital indicators, USB interfaces and DIGIFORCE® already have such an amplifier built-in.



THE MEASUREMENT SOLUTION.

**burster**

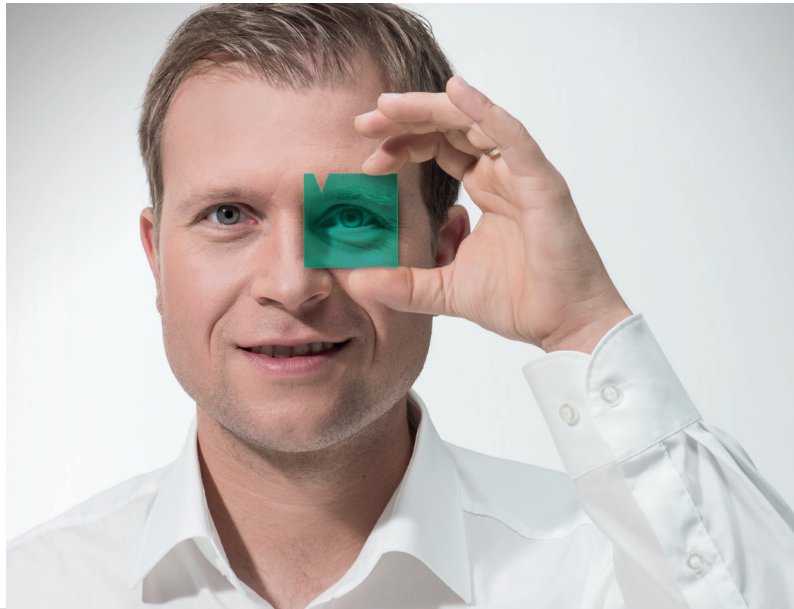
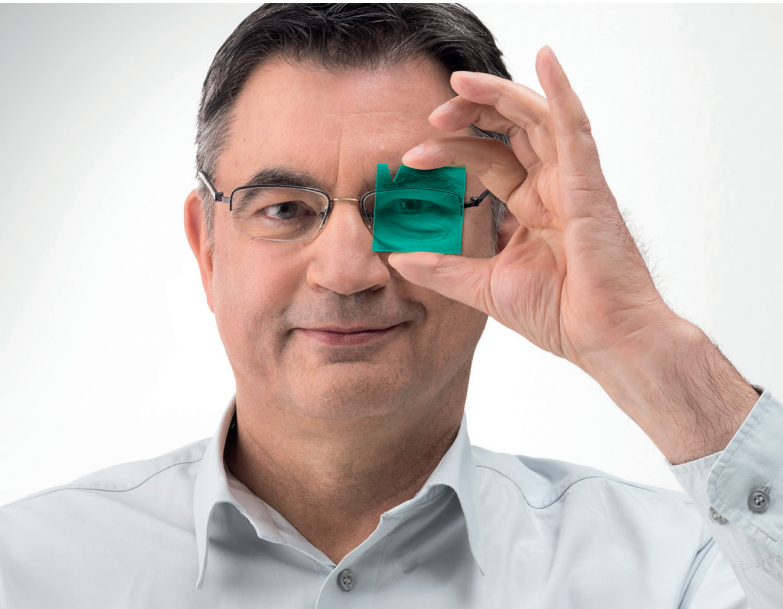

**BECAUSE PROGRESS NEEDS VISION.**

burster, the specialist for measuring equipment and sensors, delivers the ideal solution that meets your requirements to a T. We offer you forward-looking products, system solutions and a comprehensive suite of services to supplement our product range. With personal commitment and an uncompromising focus on quality.

Measuring technology with  
perspective.

THE MEASUREMENT SOLUTION.

**burster**

burster praezisionsmesstechnik  
gmbh & co kg  
Talstr. 1-5  
76593 Gernsbach, GERMANY

Phone: +49-7224-645-0  
Fax: +49-7224-645-88  
Email: [info@burster.com](mailto:info@burster.com)  
[www.burster.com](http://www.burster.com)